



Type 526 API

protected

disclosure cat.:	II	proofread:	SSt	published date:	06/14/18	effect. date:	05/18
author:	Nieh	released by:	KUW	replaces:	initial	status:	Published
resp. depart.:	IE	date of release:	06/14/18	revision No.:	2		
doc. type:	LGS	change rep. No.:	NA	retention period:	10		

Global Standard	<b>LESER Global Standard</b> Assembly instructions for type 526 API	LGS 4104
		Page 2/45

## Contents

1	Purpose .....	2
2	Scope .....	2
3	References .....	3
4	Disclaimer.....	3
5	Qualified fitting personnel .....	3
6	General Information.....	3
7	General illustration .....	4
8	Preparation for valve assembly .....	5
8.1	Emboss the punch numbers (if requested in the order).....	5
9	Assembly of type 526 .....	5
9.1	Assembly of the nozzle and blow down ring.....	5
9.2	Screw the studs into the body. ....	7
9.3	Installation of the locking screw and screw plug.....	7
9.4	Assembly of disc assembly .....	9
9.5	Assembly of spindle/disc assembly .....	13
9.6	Assembly of the bonnet.....	24
9.7	Determination and installation of the lift stopper.....	25
9.8	Assembly of the adjusting screw .....	28
9.9	Adjusting the set pressure .....	30
9.10	Testing the seat tightness P12 .....	31
9.11	Assembly of the cap / lever .....	31
9.12	Assembly of the lift indicator.....	38
9.13	Installation of the test gag (possible for H2 and H4).....	40
9.14	Installation of the different O-ring dampers .....	41
9.15	Adjusting the set pressure.....	45
9.16	Testing the seal tightness of the back seal P21 .....	45
9.17	Sealing the valve .....	45

protected

### 1 Purpose

This LESER Global Standard (LGS) describes the assembly procedure for a LESER safety valve type 526 API.

### 2 Scope

This document must be applied to the assembly of an API safety valve in agencies and subsidiaries of LESER GmbH & Co. KG.

disclosure cat.:	II	proofread:	SSt	published date:	06/14/18	effect. date:	05/18
author:	Nieh	released by:	KUW	replaces:	initial	status:	Published
resp. depart.:	IE	date of release:	06/14/18	revision No.:	2		
doc. type:	LGS	change rep. No.:	NA	retention period:	10		

Global Standard	<b>LESER Global Standard</b> Assembly instructions for type 526 API	LGS 4104
		Page 3/45

### 3 References

- LGS 3325 (LWN 322-04)
- WI 3308-08 (LWN 308-08)
- LGS 3323 (LWN 322-03)
- WI 3324-01 (LWN 324.01)

### 4 Disclaimer

LESER puts in a great deal of effort into making up-to-date and correct documentation available. Nevertheless, LESER GmbH & Co. KG gives no guarantee that the recommended actions presented here are entirely correct and error free. This document is to be used exclusively with the specified type. LESER GmbH & Co. KG declines any liability or responsibility for the correctness and completeness of the content.

LESER GmbH & Co. KG reserves the right to change the information contained in this document, which is for the products of LESER GmbH & Co. KG and is intended for LESER subsidiaries, at any time and without prior announcement.

LESER GmbH & Co. KG is available to the users of this document to provide additional information.

### 5 Qualified fitting personnel

The assembly of LESER safety valves may only be performed by trained or qualified fitters. The qualifications must be obtained through the appropriate training measures.

### 6 General Information



- Gloves must be worn during the entire assembly.

protected

disclosure cat.:	II	proofread:	SSt	published date:	06/14/18	effect. date:	05/18
author:	Nieh	released by:	KUW	replaces:	initial	status:	Published
resp. depart.:	IE	date of release:	06/14/18	revision No.:	2		
doc. type:	LGS	change rep. No.:	NA	retention period:	10		

## 7 General illustration

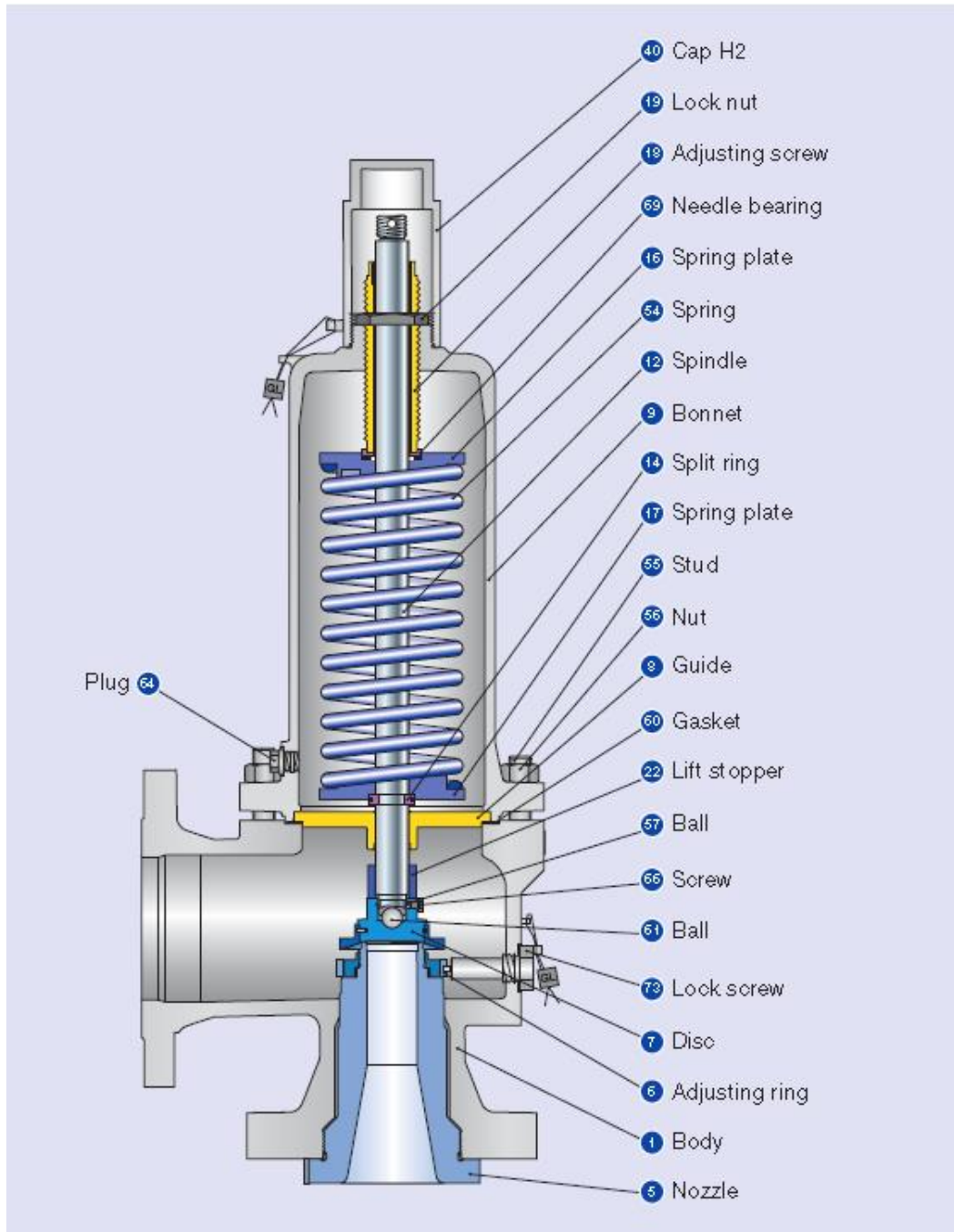

protected

Figure 7-1: Cross-sectional view of API 526

disclosure cat.:	II	proofread:	SSt	published date:	06/14/18	effect. date:	05/18
author:	Nieh	released by:	KUW	replaces:	initial	status:	Published
resp. depart.:	IE	date of release:	06/14/18	revision No.:	2		
doc. type:	LGS	change rep. No.:	NA	retention period:	10		

Global Standard	<b>LESER Global Standard</b> Assembly instructions for type 526 API	LGS 4104
		Page 5/45

## 8 Preparation for valve assembly

8.1 Emboss the punch numbers (if requested in the order).

Illustration	Description	Aids / Tools
 <p><b>Figure 8.1-1</b></p>	Emboss the code into the edge of the outlet flange (position of the code as per the work plan).	Hammer Punch numbers

## 9 Assembly of type 526

9.1 Assembly of the nozzle and blow down ring



Illustration	Description	Aids / Tools
 <p><b>Figure 9.1-1</b></p>	Grease sealing surface	Brush Assembly grease (Molykote Paste)

protected

disclosure cat.:	II	proofread:	SSt	published date:	06/14/18	effect. date:	05/18
author:	Nieh	released by:	KUW	replaces:	initial	status:	Published
resp. depart.:	IE	date of release:	06/14/18	revision No.:	2		
doc. type:	LGS	change rep. No.:	NA	retention period:	10		



Global Standard	LESER Global Standard Assembly instructions for type 526 API	LGS 4104
		Page 6/45

Illustration	Description	Aids / Tools
	<p>While screwing the nozzle into the body, the protection of the nozzle should stay in place to secure the sealing surface against damage.</p>	
 <p><b>Figure 9.1-2</b></p>	<p>Screw nozzle into the body.</p>	
 <p><b>Figure 9.1-3</b></p>	<p>Tighten nozzle with C-spanner (put a small protective slab between the nozzle and C-spanner).</p>	<p>C-spanner with a nose</p>

protected

disclosure cat.:	II	proofread:	SSt	published date:	06/14/18	effect. date:	05/18
author:	Nieh	released by:	KUW	replaces:	initial	status:	Published
resp. depart.:	IE	date of release:	06/14/18	revision No.:	2		
doc. type:	LGS	change rep. No.:	NA	retention period:	10		

Global Standard	<b>LESER Global Standard</b> Assembly instructions for type 526 API	LGS 4104
		Page 7/45



Figure 9.1-4

Screw the blow down ring completely down to the nozzle.

### 9.2 Screw the studs into the body.

Illustration	Description	Aids / Tools
	<p>Screw in the studs with an impact wrench.</p> <p><b>Tip:</b> Place the guide washer on the opening of the body so that no studs can fall on the seat.</p>	Impact wrench

Figure 9.2-1

protected

### 9.3 Installation of the locking screw and screw plug

Illustration	Description	Aids / Tools
	Grease the locking screw and screw plug.	Brush Halocarbon (OI-56 S / 60H)

Figure 9.3-1

disclosure cat.:	II	proofread:	SSt	published date:	06/14/18	effect. date:	05/18
author:	Nieh	released by:	KUW	replaces:	initial	status:	Published
resp. depart.:	IE	date of release:	06/14/18	revision No.:	2		
doc. type:	LGS	change rep. No.:	NA	retention period:	10		

Global Standard	<b>LESER Global Standard</b> Assembly instructions for type 526 API	LGS 4104
		Page 8/45



Figure 9.3-2

Grease a spacer ring for each of the screws and put on as a seal.

Illustration	Description	Aids / Tools
<p>Figure 9.3-3</p>	Screw the locking screw into the back section of the body and tighten.	Open-end spanner
<p>Figure 9.3-4</p>	Screw the screw plug into the side of the body and tighten.	Open-end and ring spanner

protected



disclosure cat.:	II	proofread:	SSt	published date:	06/14/18	effect. date:	05/18
author:	Nieh	released by:	KUW	replaces:	initial	status:	Published
resp. depart.:	IE	date of release:	06/14/18	revision No.:	2		
doc. type:	LGS	change rep. No.:	NA	retention period:	10		



Global Standard	<b>LESER Global Standard</b> Assembly instructions for type 526 API	LGS 4104
		Page 9/45

## 9.4 Assembly of disc assembly

### 9.4.1 Metal seat

Illustration	Description	Aids / Tools
 <p>Figure 9.4.1-1</p>	Put disc body and lifting aid together and clamp in place.	Clamping block
 <p>Figure 9.4.1-2</p>	Insert retaining ring and tighten with C-spanner.	C-spanner with a nose



protected

### 9.4.2 O-ring seal

Illustration	Description	Aids / Tools
 <p>Figure 9.4.2-1</p>	Individual parts of the disc assembly with O-ring seal	

disclosure cat.:	II	proofread:	SSt	published date:	06/14/18	effect. date:	05/18
author:	Nieh	released by:	KUW	replaces:	initial	status:	Published
resp. depart.:	IE	date of release:	06/14/18	revision No.:	2		
doc. type:	LGS	change rep. No.:	NA	retention period:	10		



Global Standard	<b>LESER Global Standard</b>	LGS 4104
	Assembly instructions for type 526 API	Page 10/45

Illustration	Description	Aids / Tools
 <p><b>Figure 9.4.2-2</b></p>	Wet O-ring with water and avoid any twisting when introducing it.	
 <p><b>Figure 9.4.2-3</b></p>	Insert retainer.	
 <p><b>Figure 9.4.2-4</b></p>	Screw nut onto neck and tighten. (Set torque as per LGS 3325 ).	Torque wrench with socket attachment Clamping block

protected

disclosure cat.:	II	proofread:	SSt	published date:	06/14/18	effect. date:	05/18
author:	Nieh	released by:	KUW	replaces:	initial	status:	Published
resp. depart.:	IE	date of release:	06/14/18	revision No.:	2		
doc. type:	LGS	change rep. No.:	NA	retention period:	10		

Global Standard	<b>LESER Global Standard</b> Assembly instructions for type 526 API	LGS 4104
		Page 11/45

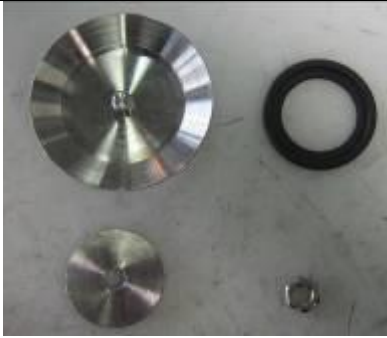
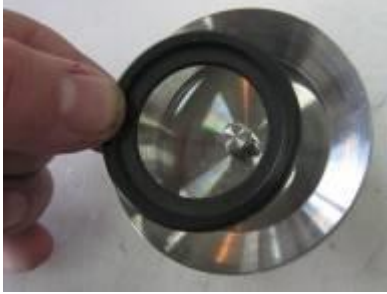

Illustration	Description	Aids / Tools
 <p><b>Figure 9.4.2-5</b></p>	Secure the nut by hitting it with a centre punch	Centre punch Hammer
 <p><b>Figure 9.4.2-6</b></p>	Emboss the marking for the O-ring material according to WI 3308-08 .	Punch numbers Hammer

protected

disclosure cat.:	II	proofread:	SSt	published date:	06/14/18	effect. date:	05/18
author:	Nieh	released by:	KUW	replaces:	initial	status:	Published
resp. depart.:	IE	date of release:	06/14/18	revision No.:	2		
doc. type:	LGS	change rep. No.:	NA	retention period:	10		

Global Standard	<b>LESER Global Standard</b> Assembly instructions for type 526 API	LGS 4104
		Page 12/45

### 9.4.3 Disc with sealing plate

Illustration	Description	Aids / Tools
 <p>Figure 9.4.3-1</p>	Individual parts of the disc assembly with sealing plate	
 <p>Figure 9.4.3-2</p>	Put the sealing plate in the disc.	
 <p>Figure 9.4.3-3</p>	Put the retainer on the sealing plate.	
 <p>Figure 9.4.3-4</p>	Screw nuts onto studs and tighten (torque as per LGS 3325 ). Secure the nut by hitting it with a centre punch Emboss the marking for the sealing plate material according to WI 3308-08 .	Torque wrench with socket attachment Centre punch Hammer Punch numbers

protected



disclosure cat.:	II	proofread:	SSt	published date:	06/14/18	effect. date:	05/18
author:	Nieh	released by:	KUW	replaces:	initial	status:	Published
resp. depart.:	IE	date of release:	06/14/18	revision No.:	2		
doc. type:	LGS	change rep. No.:	NA	retention period:	10		



Global Standard	<b>LESER Global Standard</b>	LGS 4104
	Assembly instructions for type 526 API	Page 13/45

## 9.5 Assembly of spindle/disc assembly

### 9.5.1 Assembly of spindle/disc assembly (without bellows)



Illustration	Description	Aids / Tools
 <p><b>Figure 9.5.1-1</b></p>	Insert the ball into the disc.	
 <p><b>Figure 9.5.1-2</b></p>	Push on spindle and insert small balls into the screw opening of the disc.	Possibly tweezers
 <p><b>Figure 9.5.1-3</b></p>	Screw in and tighten the clamping screw.	Ring spanner

protected

disclosure cat.:	II	proofread:	SSt	published date:	06/14/18	effect. date:	05/18
author:	Nieh	released by:	KUW	replaces:	initial	status:	Published
resp. depart.:	IE	date of release:	06/14/18	revision No.:	2		
doc. type:	LGS	change rep. No.:	NA	retention period:	10		



Global Standard	<b>LESER Global Standard</b> Assembly instructions for type 526 API	LGS 4104
		Page 14/45





Illustration	Description	Aids / Tools
 <p><b>Figure 9.5.1-4</b></p>	<p>Put on lift stopper, if requested. (variable lift stopper; possibly determine in advance; see Chap. 10)</p>	
 <p><b>Figure 9.5.1-5</b></p>	<p>Push on guide washer. Put half-washers in the recess of the spindle and secure with a retaining clip.</p>	
 <p><b>Figure 9.5.1-6</b></p>	<p>Push the lower spring plate, the spring and the upper spring plate onto the spindle.</p>	

protected

disclosure cat.:	II	proofread:	SSt	published date:	06/14/18	effect. date:	05/18
author:	Nieh	released by:	KUW	replaces:	initial	status:	Published
resp. depart.:	IE	date of release:	06/14/18	revision No.:	2		
doc. type:	LGS	change rep. No.:	NA	retention period:	10		

Global Standard	<b>LESER Global Standard</b> Assembly instructions for type 526 API	LGS 4104
		Page 15/45





### 9.5.2 Assembly of spindle/disc assembly (with stainless steel bellows)

Illustration	Description	Aids / Tools
 <p><b>Figure 9.5.2-1</b></p>	Stainless steel bellows and guide washer	
 <p><b>Figure 9.5.2-2</b></p>	Grease the sealing surface and thread of the bellows.	Brush Assembly grease (Molykote Paste)
 <p><b>Figure 9.5.2-3</b></p>	Twist the guide washer onto the bellows. In some cases, larger bellows have an inside thread and are screwed on the corresponding outside thread of the guide washer.	
	Fix the guide washer in the vice and tighten it. (Torque as per LGS_3323)	

protected

disclosure cat.:	II	proofread:	SSt	published date:	06/14/18	effect. date:	05/18
author:	Nieh	released by:	KUW	replaces:	initial	status:	Published
resp. depart.:	IE	date of release:	06/14/18	revision No.:	2		
doc. type:	LGS	change rep. No.:	NA	retention period:	10		

Global Standard	<b>LESER Global Standard</b> Assembly instructions for type 526 API	LGS 4104
		Page 16/45

Illustration	Description	Aids / Tools
 <p>Figure 9.5.2-4</p>	Stainless steel bellows and guide washer	
 <p>Figure 9.5.2-5</p>	Sparingly apply one drop to the thread of the spindle.	Glue DELO ML 5327
 <p>Figure 9.5.2-6</p>	Quickly screw the spindle together with the bellows hand tight.	
 <p>Figure 9.5.2-7</p>	Put the cooling zone onto the spindle.	

protected

disclosure cat.:	II	proofread:	SSt	published date:	06/14/18	effect. date:	05/18
author:	Nieh	released by:	KUW	replaces:	initial	status:	Published
resp. depart.:	IE	date of release:	06/14/18	revision No.:	2		
doc. type:	LGS	change rep. No.:	NA	retention period:	10		

Global Standard	<b>LESER Global Standard</b>	LGS 4104
	Assembly instructions for type 526 API	Page 17/45

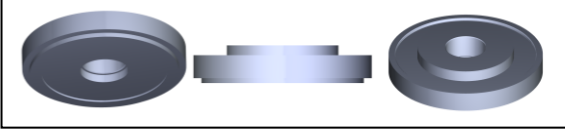
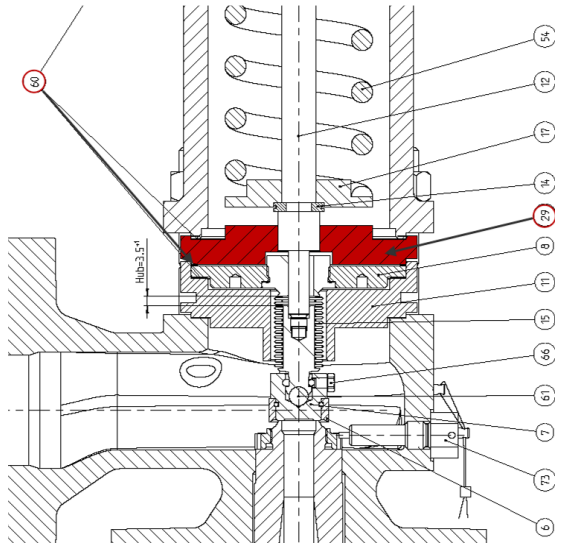

Illustration	Description	Aids / Tools
 <p><b>Figure 9.5.2-8</b></p>	Put the disc on the spindle. Put the balls into the opening of the disc, or alternatively secure the disc with a pin (depending on the disc version).	
 <p><b>Figure 9.5.2-9</b></p>	Screw the clamping screw into the disc hole.	Ring spanner
 <p><b>Figure 9.5.2-10</b></p>	Put half-washer into the recess and secure with a retaining clip.	

protected

disclosure cat.:	II	proofread:	SSt	published date:	06/14/18	effect. date:	05/18
author:	Nieh	released by:	KUW	replaces:	initial	status:	Published
resp. depart.:	IE	date of release:	06/14/18	revision No.:	2		
doc. type:	LGS	change rep. No.:	NA	retention period:	10		



### 9.5.3 Assembly spindle/disc-construction group (with stainless steel bellow and without balanced piston)



<p><b>Balanced Piston</b></p> 	<p>Operate the assembly of the stainless steel bellow like in chapter: 9.5.2. up to incl. Figure 0-8. Then assembly balanced piston as follows.</p>	
	<p>(a) Put the sealing ring (pos.60) on the guide washer.</p> <p>(b) Afterwards push the balanced piston above the spindle. (pos.29)</p>	
	<p>Put half-washer into the recess and secure with a retaining clip.</p>	

protected

disclosure cat.:	II	proofread:	SSt	published date:	06/14/18	effect. date:	05/18
author:	Nieh	released by:	KUW	replaces:	initial	status:	Published
resp. depart.:	IE	date of release:	06/14/18	revision No.:	2		
doc. type:	LGS	change rep. No.:	NA	retention period:	10		

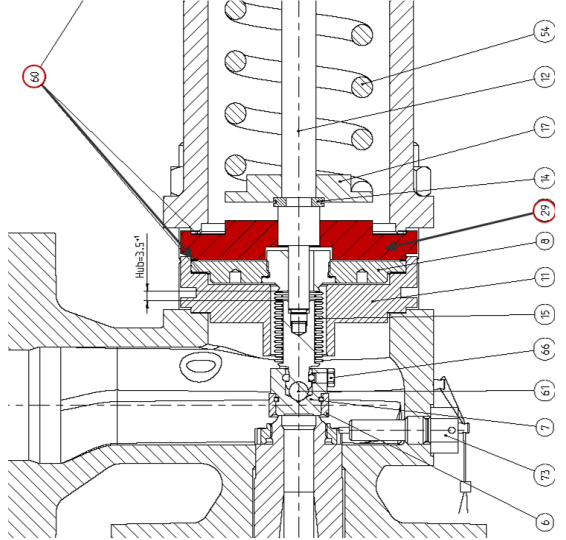

### 9.5.4 Assembly spindle/disc-construction group (with stainless steel bellow and balanced piston)



<p>Balanced piston</p> 	<p>Operate the assembly of the stainless steel bellow like in chapter: 9.5.2. up to incl. Figure 0-8. Then assembly balanced piston as follows.</p>	
	<p>(a) Put the sealing ring (pos.60) on the guide washer.</p> <p>(b) Afterwards push the balanced piston above the spindle. (pos.29)</p>	
	<p>Put half-washer into the recess and secure with a retaining clip.</p>	

protected

disclosure cat.:	II	proofread:	SSt	published date:	06/14/18	effect. date:	05/18
author:	Nieh	released by:	KUW	replaces:	initial	status:	Published
resp. depart.:	IE	date of release:	06/14/18	revision No.:	2		
doc. type:	LGS	change rep. No.:	NA	retention period:	10		

Global Standard	<b>LESER Global Standard</b> Assembly instructions for type 526 API	LGS 4104
		Page 20/45



### 9.5.5 Insert construction group (without bellow)

	<p>Insert disc/spindle construction group carefully into the body. While doing so press the guide washer down and lift the spindle slightly up, so that the disc does not land.</p> <p>Put the disc with the spindle carefully on the seat.</p>	<p>Fixture according to fixture catalogue</p>
	<p>Put the spring and the upper spring disk on the lower spring disk.</p>	

protected

disclosure cat.:	II	proofread:	SSt	published date:	06/14/18	effect. date:	05/18
author:	Nieh	released by:	KUW	replaces:	initial	status:	Published
resp. depart.:	IE	date of release:	06/14/18	revision No.:	2		
doc. type:	LGS	change rep. No.:	NA	retention period:	10		

Global Standard	<b>LESER Global Standard</b> Assembly instructions for type 526 API	LGS 4104
		Page 21/45



	<p>If applicable, grease the axial needle roller on the top spring plate.</p>	<p>Brush Halocarbon (OI-56 S / 60H)</p>
	<p>Put the bearing washer on the axial needle roller and grease.</p>	<p>Brush Halocarbon (OI-56 S / 60H)</p>

protected

disclosure cat.:	II	proofread:	SSt	published date:	06/14/18	effect. date:	05/18
author:	Nieh	released by:	KUW	replaces:	initial	status:	Published
resp. depart.:	IE	date of release:	06/14/18	revision No.:	2		
doc. type:	LGS	change rep. No.:	NA	retention period:	10		

Global Standard	<b>LESER Global Standard</b> Assembly instructions for type 526 API	LGS 4104
		Page 22/45

### 9.5.6 Inserting the spindle/disc assembly (with stainless steel bellows)

Illustration	Description	Aids / Tools
	<p>Put the sealing into the body.</p>	
 <p><b>Figure 9.5.3-1</b></p>	<p>Insert the spindle/disc/cooling zone into the body. In the process, push the guide washer down and lift the spindle somewhat so that the disc does not touch down.                      Carefully put the disc with the spindle down on the seat.</p>	

protected

disclosure cat.:	II	proofread:	SSt	published date:	06/14/18	effect. date:	05/18
author:	Nieh	released by:	KUW	replaces:	initial	status:	Published
resp. depart.:	IE	date of release:	06/14/18	revision No.:	2		
doc. type:	LGS	change rep. No.:	NA	retention period:	10		





Figure 9.5.3-2



Put the bottom spring plate, the spring and the top spring plate on one after the other.

protected

disclosure cat.:	II	proofread:	SSt	published date:	06/14/18	effect. date:	05/18
author:	Nieh	released by:	KUW	replaces:	initial	status:	Published
resp. depart.:	IE	date of release:	06/14/18	revision No.:	2		
doc. type:	LGS	change rep. No.:	NA	retention period:	10		



Global Standard	<b>LESER Global Standard</b> Assembly instructions for type 526 API	LGS 4104
		Page 24/45

Illustration	Description	Aids / Tools
 <p><b>Figure 9.5.3-3</b></p>	If applicable, grease the axial needle roller on the top spring plate.	Brush Halocarbon (OI-56 S / 60H)
 <p><b>Figure 9.5.3-4</b></p>	Put the bearing washer on the axial needle roller and grease.	Brush Halocarbon (OI-56 S / 60H)

protected

## 9.6 Assembly of the bonnet

Illustration	Description	Aids / Tools
 <p><b>Figure 9.6-1</b></p>	Put the bonnet on the studs. Screw nuts onto the studs and tighten. (Set torque as per LGS 3323).	Torque wrench



disclosure cat.:	II	proofread:	SSt	published date:	06/14/18	effect. date:	05/18
author:	Nieh	released by:	KUW	replaces:	initial	status:	Published
resp. depart.:	IE	date of release:	06/14/18	revision No.:	2		
doc. type:	LGS	change rep. No.:	NA	retention period:	10		

Global Standard	<b>LESER Global Standard</b> Assembly instructions for type 526 API	LGS 4104
		Page 25/45

## 9.7 Determination and installation of the lift stopper

### 9.7.1 Lift stopper with ring/sleeve

#### 9.7.1.1 Procedure for small valves without bellows (up to approx. DN 65 / 2 1/2").

Illustration	Description	Aids / Tools
 <p><b>Figure 9.7.1.1-1</b></p>	<p>Take the extent to which the stroke has to be limited from the work order. Insert the spindle/disc assembly without the spring and spring plate. Put on the bonnet and tighten the nuts. Make the adjusting screw and spindle flush.</p>	
 <p><b>Figure 9.7.1.1-2</b></p>	<p>Clamp the body on the outlet in the vice. Lift the disc with a screwdriver through the inlet as far as it will go.</p>	<p>Screwdriver Clamping block</p>
 <p><b>Figure 9.7.1.1-3</b></p>	<p>Measure the spindle overlap in an opened state. Deduct the requested stroke from this measurement and have a lift stopper made.</p>	<p>Sliding Vernier calliper</p>

protected

disclosure cat.:	II	proofread:	SSt	published date:	06/14/18	effect. date:	05/18
author:	Nieh	released by:	KUW	replaces:	initial	status:	Published
resp. depart.:	IE	date of release:	06/14/18	revision No.:	2		
doc. type:	LGS	change rep. No.:	NA	retention period:	10		

Global Standard	<b>LESER Global Standard</b> Assembly instructions for type 526 API	LGS 4104
		Page 26/45

9.7.1.2 Procedure for large valves without bellows (as of approx. DN 80 / 3").

Illustration	Description	Aids / Tools
 <p><b>Figure 9.7.1.2-1</b></p>	<p>Carefully put the disc on the nozzle and put the sealing ring in the body.</p> <p>Take the extent to which the stroke has to be limited from the job order.</p>	
 <p><b>Figure 9.7.1.2-2</b></p>	<p>Put the guide washer on the body.</p>	
 <p><b>Figure 9.7.1.2-3</b></p>	<p>Use the depth gauge to measure the path from the top edge of the guide washer to the top edge of the disc.</p> <p>Deduct the measurement of the guide washer as well as the desired stroke from the order and have the lift stopper made.</p>	

protected

disclosure cat.:	II	proofread:	SSt	published date:	06/14/18	effect. date:	05/18
author:	Nieh	released by:	KUW	replaces:	initial	status:	Published
resp. depart.:	IE	date of release:	06/14/18	revision No.:	2		
doc. type:	LGS	change rep. No.:	NA	retention period:	10		

Global Standard	<b>LESER Global Standard</b>	LGS 4104
	Assembly instructions for type 526 API	Page 27/45

9.7.2 Lift stopper with set screw (taken from WI 3324-01)

Illustration	Description	Aids / Tools
	<p>Take the extent to which the stroke has to be limited from the job order.</p> <p>Use a completely assembled valve to measure the distance from the top edge of the cap/lever to the end of the spindle.</p> <p>Deduct the measurement of the guide washer as well as the desired stroke from the order and have the lift stopper made.</p> <p>Seal the screws with PTFE tape, screw them in and tighten. (Set torque as per LGS 3323).</p>	<p>PTFE tape Sliding Vernier calliper</p>

Figure 9.7.1.2-1

protected

disclosure cat.:	II	proofread:	SSt	published date:	06/14/18	effect. date:	05/18
author:	Nieh	released by:	KUW	replaces:	initial	status:	Published
resp. depart.:	IE	date of release:	06/14/18	revision No.:	2		
doc. type:	LGS	change rep. No.:	NA	retention period:	10		

Global Standard	<b>LESER Global Standard</b> Assembly instructions for type 526 API	LGS 4104
		Page 28/45

## 9.8 Assembly of the adjusting screw

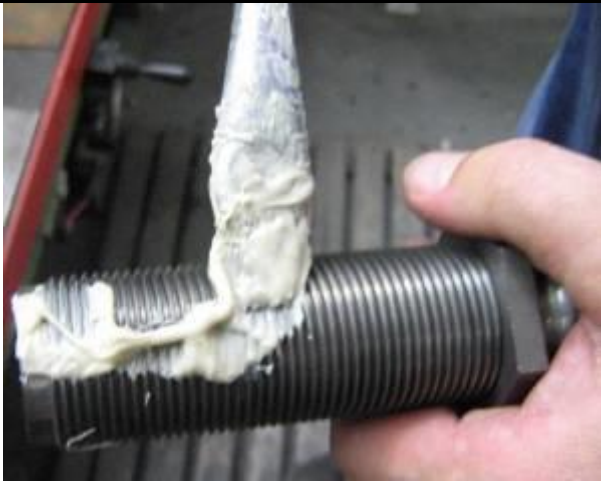

Illustration	Description	Aids / Tools
 <p><b>Figure 9.8-1</b></p>	Individual parts of the adjusting screw	
 <p><b>Figure 9.8-2</b></p>	Put the bushing in the adjusting screw.	
 <p><b>Figure 9.8-3</b></p>	Screw the lock nut on approximately three-quarters of the way down the adjusting screw.	

protected

disclosure cat.:	II	proofread:	SSt	published date:	06/14/18	effect. date:	05/18
author:	Nieh	released by:	KUW	replaces:	initial	status:	Published
resp. depart.:	IE	date of release:	06/14/18	revision No.:	2		
doc. type:	LGS	change rep. No.:	NA	retention period:	10		



Global Standard	<b>LESER Global Standard</b>	LGS 4104
	Assembly instructions for type 526 API	Page 29/45



Illustration	Description	Aids / Tools
 <p><b>Figure 9.8-4</b></p>	Grease adjusting screw	Brush Assembly grease (Molykote Paste)
 <p><b>Figure 9.8-5</b></p>	Screw the adjusting screw into the bonnet until resistance from the spring is felt.	

protected

disclosure cat.:	II	proofread:	SSt	published date:	06/14/18	effect. date:	05/18
author:	Nieh	released by:	KUW	replaces:	initial	status:	Published
resp. depart.:	IE	date of release:	06/14/18	revision No.:	2		
doc. type:	LGS	change rep. No.:	NA	retention period:	10		

Global Standard	<b>LESER Global Standard</b> Assembly instructions for type 526 API	LGS 4104
		Page 30/45

## 9.9 Adjusting the set pressure

Illustration	Description	Aids / Tools
 <p><b>Figure 9.9-1</b></p>	Secure the spindle from turning with a pin punch.	Pin punch Open-end spanner
 <p><b>Figure 9.9-2</b></p>	<p>Slowly pressurise the valve on the test bench to find out whether the valve opens at the set pressure. The set pressure of the valve has been reached when you can hear air escaping. Full opening must be achieved.</p> <p>If the valve opens outside the stipulated set pressure tolerance, then the adjusting screw must be adjusted again.</p> <p>Turning in a clockwise direction causes the valve to open at higher pressure.</p> <p>Turning in a counter-clockwise direction causes the valve to open at lower pressure.</p> <p>Release the pressure when readjusting the adjusting screw. Readjust the adjusting screw and then pressurise the valve again.</p>	Open-end spanner
 <p><b>Figure 9.9-2</b></p>	<p>If the pressure setting has been completed, secure the adjusting screw with a lock nut.</p> <p>Afterwards, check the set pressure once again.</p>	Open-end spanner

protected

disclosure cat.:	II	proofread:	SSt	published date:	06/14/18	effect. date:	05/18
author:	Nieh	released by:	KUW	replaces:	initial	status:	Published
resp. depart.:	IE	date of release:	06/14/18	revision No.:	2		
doc. type:	LGS	change rep. No.:	NA	retention period:	10		

Global Standard	<b>LESER Global Standard</b> Assembly instructions for type 526 API	LGS 4104
		Page 31/45



## 9.10 Testing the seat tightness P12

This test is performed for every valve after setting the pressure.

The exact execution of the test is described in a separate work instruction **AA-EF-013**.

## 9.11 Assembly of the cap / lever

### 9.11.1 Assembly of cap H2





Illustration	Description	Aids / Tools
 <p><b>Figure 9.11.1-1</b></p>	Grease the thread and sealing face of the cap.	Brush Halocarbon (OI-56 S / 60H)
 <p><b>Figure 9.11.1-2</b></p>	Screw on the cap and tighten with a spanner. (Set torque as per LGS 3323).	Open-end spanner

protected

disclosure cat.:	II	proofread:	SSt	published date:	06/14/18	effect. date:	05/18
author:	Nieh	released by:	KUW	replaces:	initial	status:	Published
resp. depart.:	IE	date of release:	06/14/18	revision No.:	2		
doc. type:	LGS	change rep. No.:	NA	retention period:	10		

Global Standard	<b>LESER Global Standard</b> Assembly instructions for type 526 API	LGS 4104
		Page 32/45

### 9.11.2 Assembly of lever H3





Illustration	Description	Aids / Tools
 <p><b>Figure 9.11.2-1</b></p>	Put the spindle cap onto the spindle and secure with a pin and retaining clip.	
 <p><b>Figure 9.11.2-2</b></p>	Put clamping screw into H3 cap at designated place.	Ring spanner
 <p><b>Figure 9.11.2-3</b></p>	Put the small plastic balls in the hole of the adjusting screw.	
 <p><b>Figure 9.11.2-4</b></p>	Grease the thread of the lever and screw it onto the bonnet (lever must be opposite from outlet).	Brush Halocarbon (OI-56 S / 60H)

protected

disclosure cat.:	II	proofread:	SSt	published date:	06/14/18	effect. date:	05/18
author:	Nieh	released by:	KUW	replaces:	initial	status:	Published
resp. depart.:	IE	date of release:	06/14/18	revision No.:	2		
doc. type:	LGS	change rep. No.:	NA	retention period:	10		



Global Standard	LESER Global Standard Assembly instructions for type 526 API	LGS 4104
		Page 33/45

Illustration	Description	Aids / Tools
 <p><b>Figure 9.11.2-5</b></p>	Insert the venting lever into the spindle cap.	
 <p><b>Figure 9.11.2-6</b></p>	Use a pin and retaining washers to secure the venting lever.	
 <p><b>Figure 9.11.2-7</b></p>	Make sure that the lever has enough play to vent.	
 <p><b>Figure 9.11.2-8</b></p>	Tighten the clamping screw on the lever.	Ring spanner

protected

disclosure cat.:	II	proofread:	SSt	published date:	06/14/18	effect. date:	05/18
author:	Nieh	released by:	KUW	replaces:	initial	status:	Published
resp. depart.:	IE	date of release:	06/14/18	revision No.:	2		
doc. type:	LGS	change rep. No.:	NA	retention period:	10		

Global Standard	<b>LESER Global Standard</b> Assembly instructions for type 526 API	LGS 4104
		Page 34/45





### 9.11.3 Special assembly of the Cap H3

There are different variations to assemble the H3 Cap.

The variation A describes the standard variation.

The variation B is pulled by the option code M08 and as well shown in the work plan.

The variations B and C are dealt with exclusively in the EOM.

Variante	Beschreibung	Steuerung	H3 Anlüftung
A	Position: Standard	-/-	
B	Position: 90° versetzt zum Standard (Richtung Austritt)	Sonder	
C	Position: 180° versetzt zum Standard (Richtung Austritt)	M08	
D	Position: 270° versetzt zum Standard (Richtung Austritt)	Sonder	

protected

disclosure cat.:	II	proofread:	SSt	published date:	06/14/18	effect. date:	05/18
author:	Nieh	released by:	KUW	replaces:	initial	status:	Published
resp. depart.:	IE	date of release:	06/14/18	revision No.:	2		
doc. type:	LGS	change rep. No.:	NA	retention period:	10		

## Cap H4

### 9.11.4 Test of the lifting fork position

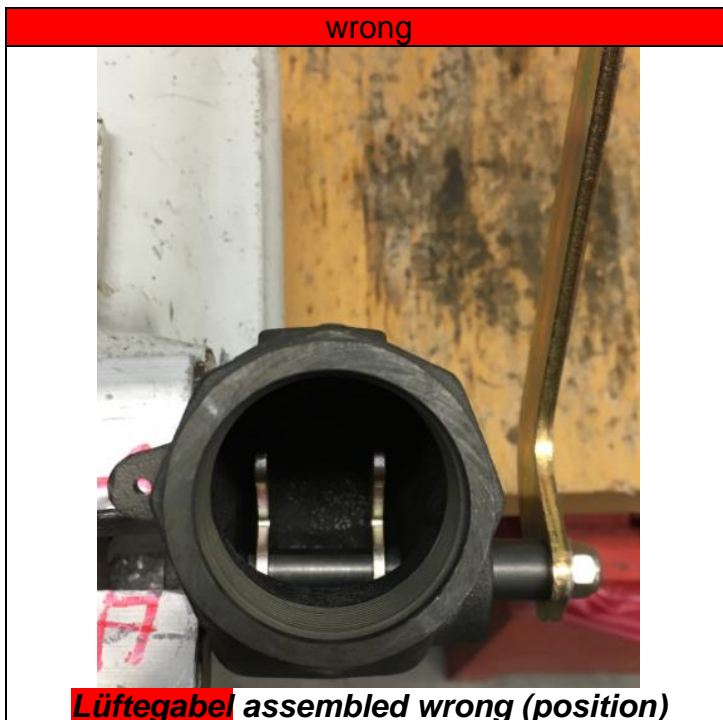
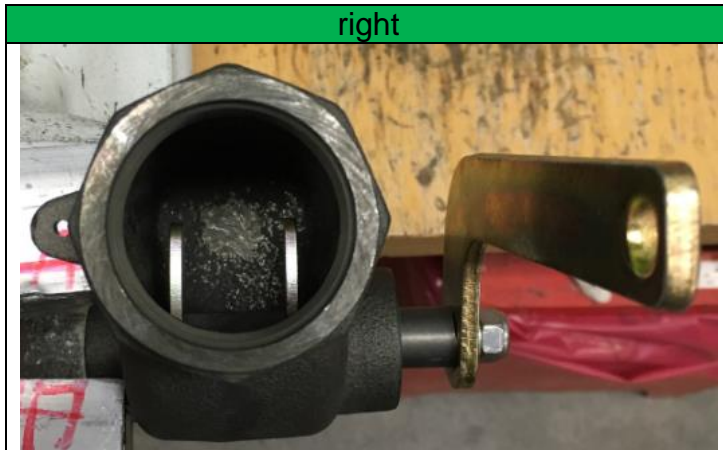

#### 1. working steps

- Before the assembly of the already assembled H4 cap the position of the lifting fork within the cap has to be checked to guarantee that the cap is working properly.
- With it take a look from the thread side into the cap and check the position of the lifting fork.

protected

#### 2. aid

- k.A.

#### 3. tool

- k.A.



#### 4. device

- k.A.

disclosure cat.:	II	proofread:	SSt	published date:	06/14/18	effect. date:	05/18
author:	Nieh	released by:	KUW	replaces:	initial	status:	Published
resp. depart.:	IE	date of release:	06/14/18	revision No.:	2		
doc. type:	LGS	change rep. No.:	NA	retention period:	10		

Global Standard	<b>LESER Global Standard</b> Assembly instructions for type 526 API	LGS 4104
		Page 36/45

### 9.11.5 Assembly of lever H4

Illustration	Description	Aids / Tools
 <p><b>Figure 9.11.5-1</b></p>	Put the spindle cap onto the spindle and secure with a pin and retaining clip.	
 <p><b>Figure 9.11.5-2</b></p>	Align the lever with sealing rings so that the lever arm is parallel to the outlet.	
 <p><b>Figure 9.11.5-3</b></p>	Grease the lever and sealing rings. Put them on and tighten with an open-end spanner (torque as per LGS 3323).	Open-end spanner Torque wrench

protected

disclosure cat.:	II	proofread:	SSt	published date:	06/14/18	effect. date:	05/18
author:	Nieh	released by:	KUW	replaces:	initial	status:	Published
resp. depart.:	IE	date of release:	06/14/18	revision No.:	2		
doc. type:	LGS	change rep. No.:	NA	retention period:	10		



### 9.11.6 Special assembly of the cap H4

There are different variations to assemble the H4 cap.

The variation A describes the standard variation.

The variation B is pulled by the option code M08 and as well shown in the work plan.

The variations B and C are dealt with exclusively in the EOM.

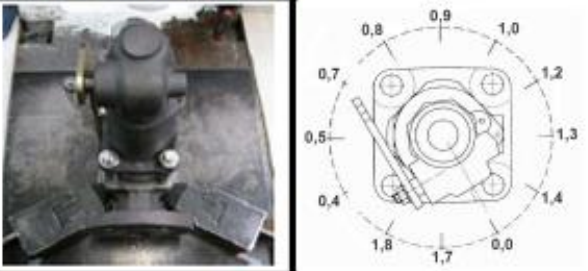
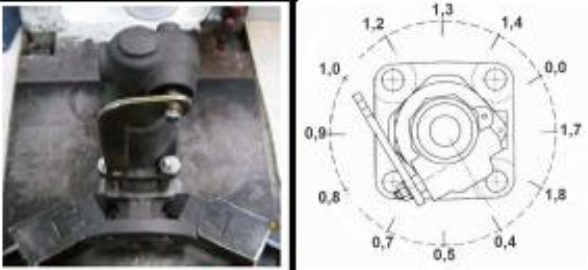
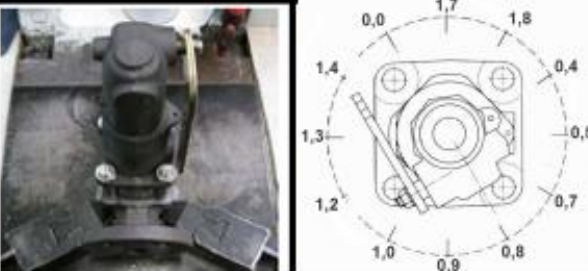
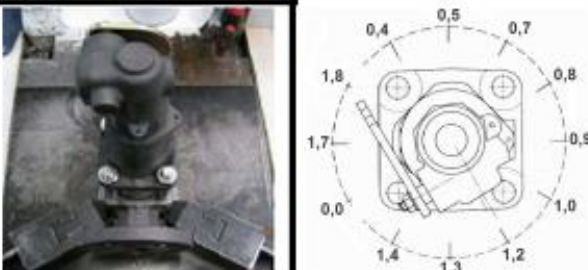

Variante	Beschreibung	Steuerung	H4 Anlüftung
A	Position: Standard	-/-	
B	Position: 90° versetzt zum Standard (Richtung Austritt)	Sonder	
C	Position: 180° versetzt zum Standard (Richtung Austritt)	M08	
D	Position: 270° versetzt zum Standard (Richtung Austritt)	Sonder	

protected

disclosure cat.:	II	proofread:	SSt	published date:	06/14/18	effect. date:	05/18
author:	Nieh	released by:	KUW	replaces:	initial	status:	Published
resp. depart.:	IE	date of release:	06/14/18	revision No.:	2		
doc. type:	LGS	change rep. No.:	NA	retention period:	10		

Global Standard	<b>LESER Global Standard</b>	LGS 4104
	Assembly instructions for type 526 API	Page 38/45

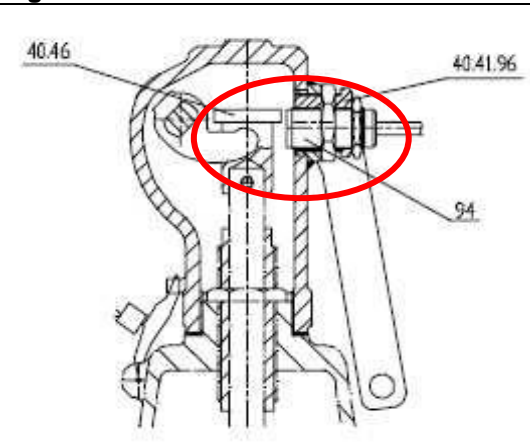

## 9.12 Assembly of the lift indicator

Illustration	Description	Aids / Tools
 <p><b>Figure 9.12-1</b></p>	Individual parts of the lift indicator	
 <p><b>Figure 9.12-2</b></p>	Put the cap into position as described in 13.3 and secure.	Open-end spanner
 <p><b>Figure 9.12-3</b></p>	Put the eccentric hole of the holder into such a position that the collar of the spindle cap would seal on top with the edge of the lift indicator (see illustration).	

protected

disclosure cat.:	II	proofread:	SSt	published date:	06/14/18	effect. date:	05/18
author:	Nieh	released by:	KUW	replaces:	initial	status:	Published
resp. depart.:	IE	date of release:	06/14/18	revision No.:	2		
doc. type:	LGS	change rep. No.:	NA	retention period:	10		

Global Standard	<b>LESER Global Standard</b>	LGS 4104
	Assembly instructions for type 526 API	Page 39/45



Illustration	Description	Aids / Tools
 <p><b>Figure 9.12-4</b></p>	<p>Secure the position with a lock nut.</p>	
 <p><b>Figure 9.12-5</b></p>	<p>Screw the lift indicator into the collar of the spindle cap as far as it will go. Then unscrew it one complete turn. Secure the position of the lift indicator by tightening the first nut hand tight. Then lock with a second nut.</p>	

protected

disclosure cat.:	II	proofread:	SSt	published date:	06/14/18	effect. date:	05/18
author:	Nieh	released by:	KUW	replaces:	initial	status:	Published
resp. depart.:	IE	date of release:	06/14/18	revision No.:	2		
doc. type:	LGS	change rep. No.:	NA	retention period:	10		

Global Standard	<b>LESER Global Standard</b>	LGS 4104
	Assembly instructions for type 526 API	Page 40/45

### 9.13 Installation of the test gag (possible for H2 and H4)

Illustration	Description	Aids / Tools
 <p><b>Figure 9.13-1</b></p>	Grease the sealing surface of the short bolt.	Brush Halocarbon (OI-56 S / 60H)
 <p><b>Figure 9.13-2</b></p>	Put on the sealing ring and grease it as well.	Brush Halocarbon (OI-56 S / 60H)
 <p><b>Figure 9.13-3</b></p>	Screw the test gag into the cap or lever and tighten (torque as per LGS 3323).	

protected

disclosure cat.:	II	proofread:	SSt	published date:	06/14/18	effect. date:	05/18
author:	Nieh	released by:	KUW	replaces:	initial	status:	Published
resp. depart.:	IE	date of release:	06/14/18	revision No.:	2		
doc. type:	LGS	change rep. No.:	NA	retention period:	10		



Global Standard	<b>LESER Global Standard</b> Assembly instructions for type 526 API	LGS 4104
		Page 41/45

## 9.14 Installation of the different O-ring dampers



### 9.14.1 O-ring damper H2

Illustration	Description	Aids / Tools
 <p><b>Figure 9.14.1-1</b></p>	Individual parts of the O-ring damper H2	
 <p><b>Figure 9.14.1-2</b></p>	Put the support sleeve onto the adjusting screw.	
 <p><b>Figure 9.14.1-3</b></p>	Put O-ring onto the spindle over the support sleeve. The O-ring must not sit on the cross hole or a thread, if one is present. 	

protected

disclosure cat.:	II	proofread:	SSt	published date:	06/14/18	effect. date:	05/18
author:	Nieh	released by:	KUW	replaces:	initial	status:	Published
resp. depart.:	IE	date of release:	06/14/18	revision No.:	2		
doc. type:	LGS	change rep. No.:	NA	retention period:	10		

Global Standard	<b>LESER Global Standard</b>	LGS 4104
	Assembly instructions for type 526 API	Page 42/45



Illustration	Description	Aids / Tools
 <p><b>Figure 9.14.1-4</b></p>	Put the counter ring onto the O-ring or support sleeve.	
 <p><b>Figure 9.14.1-5</b></p>	Put retaining spring onto the counter ring.	
 <p><b>Figure 9.14.1-6</b></p>	Grease the cap on the thread. Screw it onto the bonnet and tighten (torque as per LGS 3323).	Open-end spanner

protected

disclosure cat.:	II	proofread:	SSt	published date:	06/14/18	effect. date:	05/18
author:	Nieh	released by:	KUW	replaces:	initial	status:	Published
resp. depart.:	IE	date of release:	06/14/18	revision No.:	2		
doc. type:	LGS	change rep. No.:	NA	retention period:	10		



Global Standard	<b>LESER Global Standard</b> Assembly instructions for type 526 API	LGS 4104
		Page 43/45

### 9.14.2 O-ring damper H4

Illustration	Description	Aids / Tools
 <p><b>Figure 9.14.2-1</b></p>	Individual parts of the O-ring damper H4	
 <p><b>Figure 9.14.2-2</b></p>	Fasten the O-ring damper on the spindle with a steel pin and retaining clip. Then assemble the H4 lever cover as described in 12.43.	
 <p><b>Figure 9.14.2-3</b></p>		

protected

disclosure cat.:	II	proofread:	SSt	published date:	06/14/18	effect. date:	05/18
author:	Nieh	released by:	KUW	replaces:	initial	status:	Published
resp. depart.:	IE	date of release:	06/14/18	revision No.:	2		
doc. type:	LGS	change rep. No.:	NA	retention period:	10		

Illustration	Description	Aids / Tools
 <p>Figure 9.14.2-4</p>	<p>Put the first O-ring - counter ring - second O-ring - support sleeve - spring - cap onto the lever one after the other.</p>	
 <p>Figure 9.14.2-5</p>		
 <p>Figure 9.14.2-6</p>	<p>Grease, screw on and tighten the thread and sealing lip of the cap (torque as per LGS 3323).</p>	<p>Halocarbon (OI-56 S / 60H) Open-end spanner</p>

protected

disclosure cat.:	II	proofread:	SSt	published date:	06/14/18	effect. date:	05/18
author:	Nieh	released by:	KUW	replaces:	initial	status:	Published
resp. depart.:	IE	date of release:	06/14/18	revision No.:	2		
doc. type:	LGS	change rep. No.:	NA	retention period:	10		



Global Standard	<b>LESER Global Standard</b> Assembly instructions for type 526 API	LGS 4104
		Page 45/45

### 9.15 Adjusting the set pressure

Pressurise the valve as per the workplace description.

Check whether the valve opens at the set pressure. The set pressure of the valve has been reached when the pressure display remains constant when the line pressure increases. It must fully open.

The valve must open within the tolerance range 3 times in succession.

Document the set pressure.

### 9.16 Testing the seal tightness of the back seal P21 (seal tightness to the outside)

This test is performed for every gas-tight valve after its assembly.

### 9.17 Sealing the valve

Illustration	Description	Aids / Tools
 <p><b>Figure 9.17-1</b></p>	<p>If structurally possible (sealing hole/lug on cap/lever and bonnet exist), then seal the valve. Otherwise sealing lugs must be welded on. Closely connect the sealing hole or lug from the cap/lever and bonnet in a clockwise direction, and connect the locking screw and sealing lug with sealing wire and seal the ends of the wire with a lead seal. If classification approvals (TÜV etc.) are required, then seal afterwards.</p>	<p>Sealing pliers Wire twisting pliers Sealing block Wire</p>

protected

disclosure cat.:	II	proofread:	SSt	published date:	06/14/18	effect. date:	05/18
author:	Nieh	released by:	KUW	replaces:	initial	status:	Published
resp. depart.:	IE	date of release:	06/14/18	revision No.:	2		
doc. type:	LGS	change rep. No.:	NA	retention period:	10		