



LESER

The-Safety-Valve.com



The Company – Your entry into the world of LESER.

MISSION	04	For the protection of people, the environment and industry...
SUSTAINABILITY	06	LESER acts responsibly.
EXPERTISE	08	Safety, proven a million times.
HISTORY	10	“Celebrating 200 years of existence is not a reward in itself...”
FLEXIBILITY	12	Customized for your application.
DEVELOPMENT	14	LESER sets the standard in product development.
TEST LAB	16	LESER is constantly learning.
CERTIFICATION	18	The Safety Valve for the whole world.
QUALITY ASSURANCE	20	Manufacturing with built-in quality.
PRODUCTION – OPERATIONAL	22	Fast, quantity and reliable.
PRODUCTION – PROJECTS	24	Flexible, precise and clear.
PRODUCTS	26	LESER – The Safety Valve for all industrial applications.
DIGITAL SERVICES	32	eLESER. Digital makes it easier.
TRAINING	34	experienceLESER. Knowledge for more safety.
AFTERMARKET	36	LESER – also with you afterwards.
TRANSPARENCY	38	Trust through transparency.
NETWORK	40	Worldwide, at your side.
LESER KONTOR	42	The Home of Safety Valves.
LESER HOHENWESTEDT	44	The Factory of Safety Valves.
LESER GLOBAL	46	Subsidiaries



For the protection of people,
the environment and industry...

■ ... you can trust the LESER brand. More than 1,000 employees worldwide work for you on this promise. Made in Germany for more than 200 years.

LESER acts responsibly.

■ LESER Safety Valves are designed to last up to 30 years. They can be repaired and adapted to changing operating conditions using original spare parts in a resource-saving manner. Whenever possible, we use self-generated electricity from renewable energy sources. LESER has developed occupational health and safety regulations that often exceed national regulations. Our planning and actions for profitable and sustainable growth are focused on the mid to long term. Our commitment to sustainable development is verified through external audits and assessments. LESER has joined the UN Global Compact.



Safety, proven a million times.

- LESER Safety Valves safeguard plants and processes from overpressure incidents. The basis is the LESER product range with nine product groups, 40 types, 1,500 options and over 2,000,000 possible configurations.

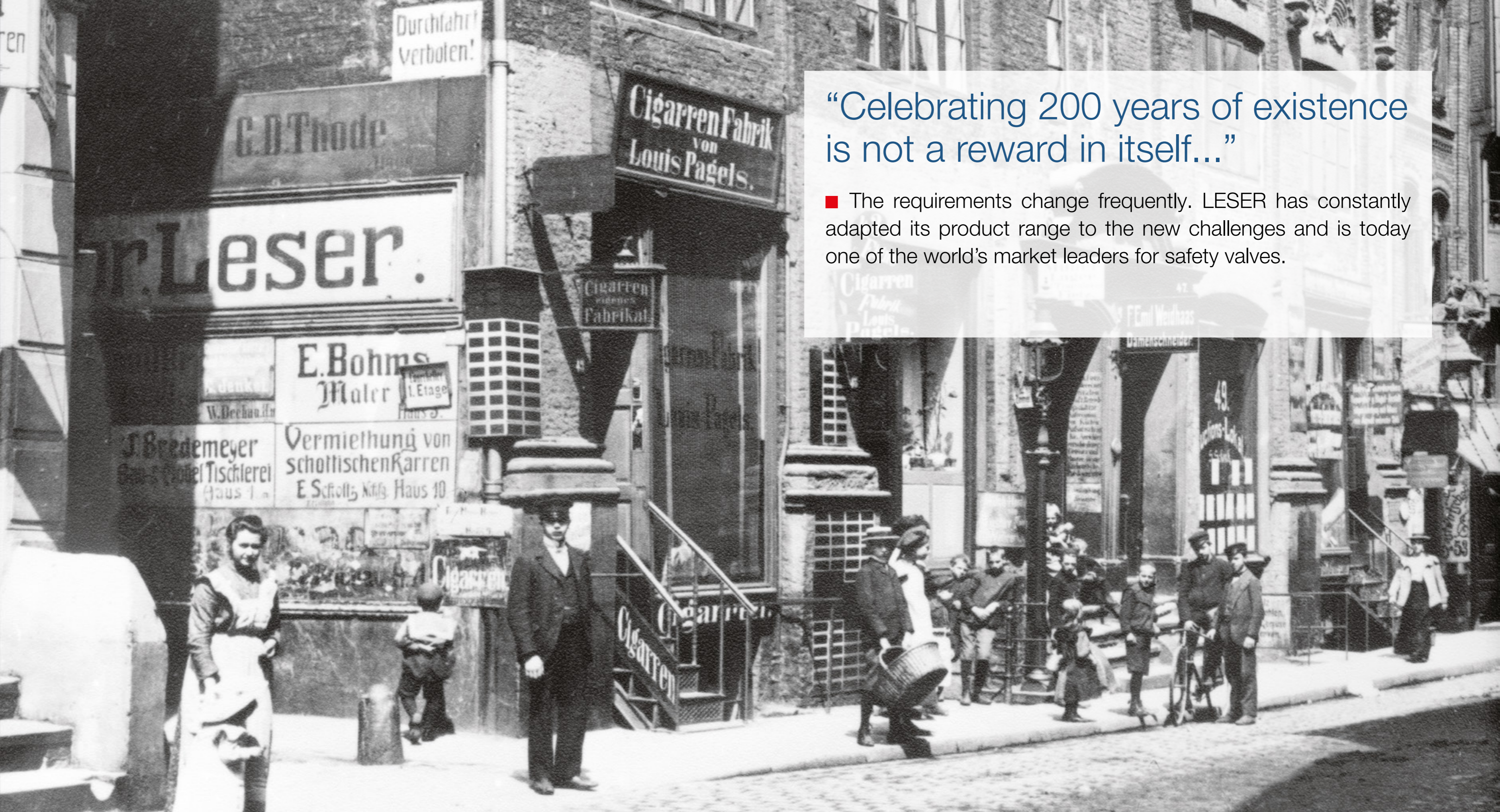

“Celebrating 200 years of existence is not a reward in itself...”

- The requirements change frequently. LESER has constantly adapted its product range to the new challenges and is today one of the world's market leaders for safety valves.



Customized for your application.

■ LESER finds the right solution for you. VALVESTAR® is the tool for sizing and selecting Safety Valves. For particularly challenging process conditions, we will advise you comprehensively so that almost any requirement can be met.

LESER sets the standard in product development.

- Casting simulation software, finite element analysis and flow simulation – digital tools, combined with the practical experience gained from 1.5 million Safety Valves in operation, form the basis for innovative product development.

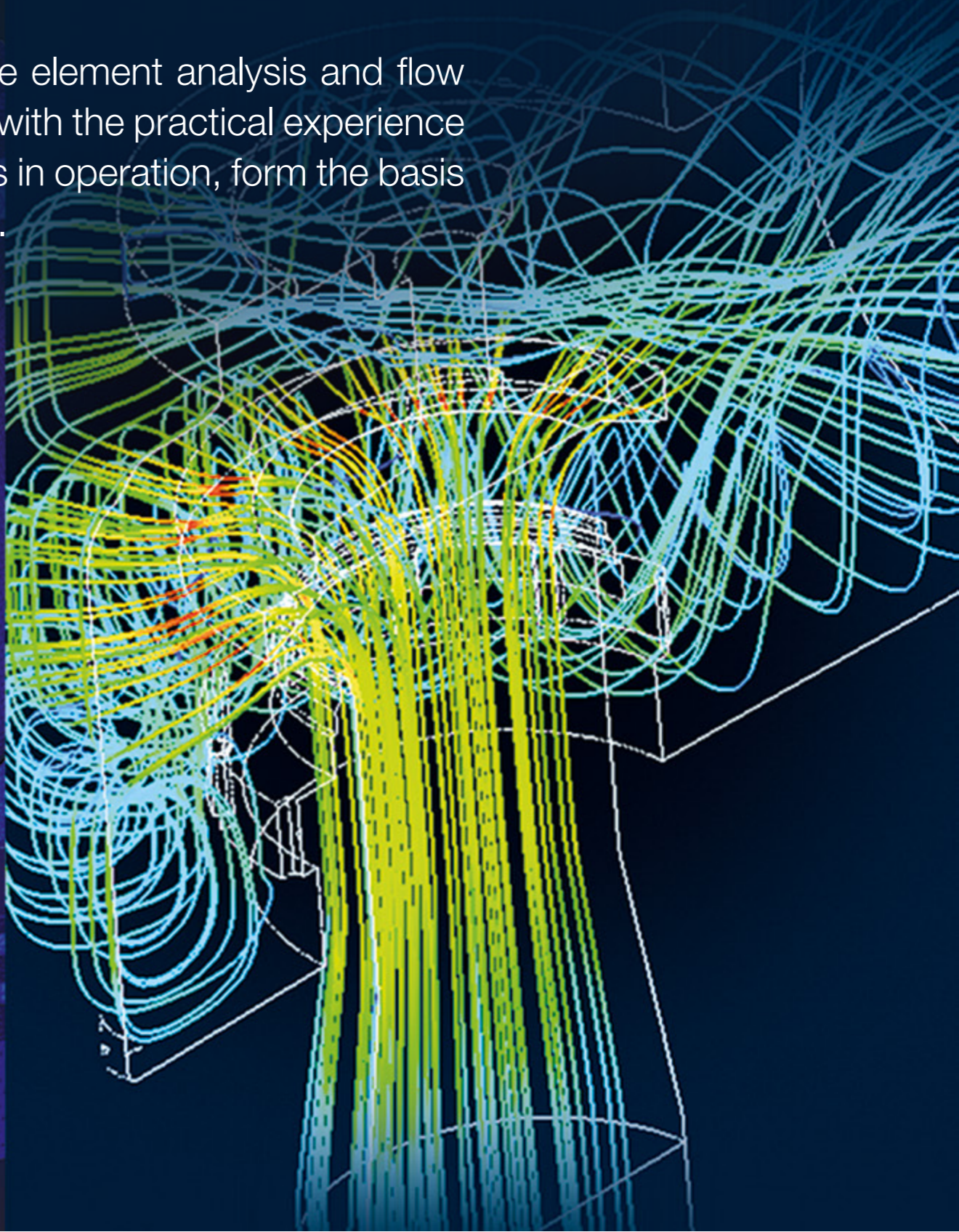
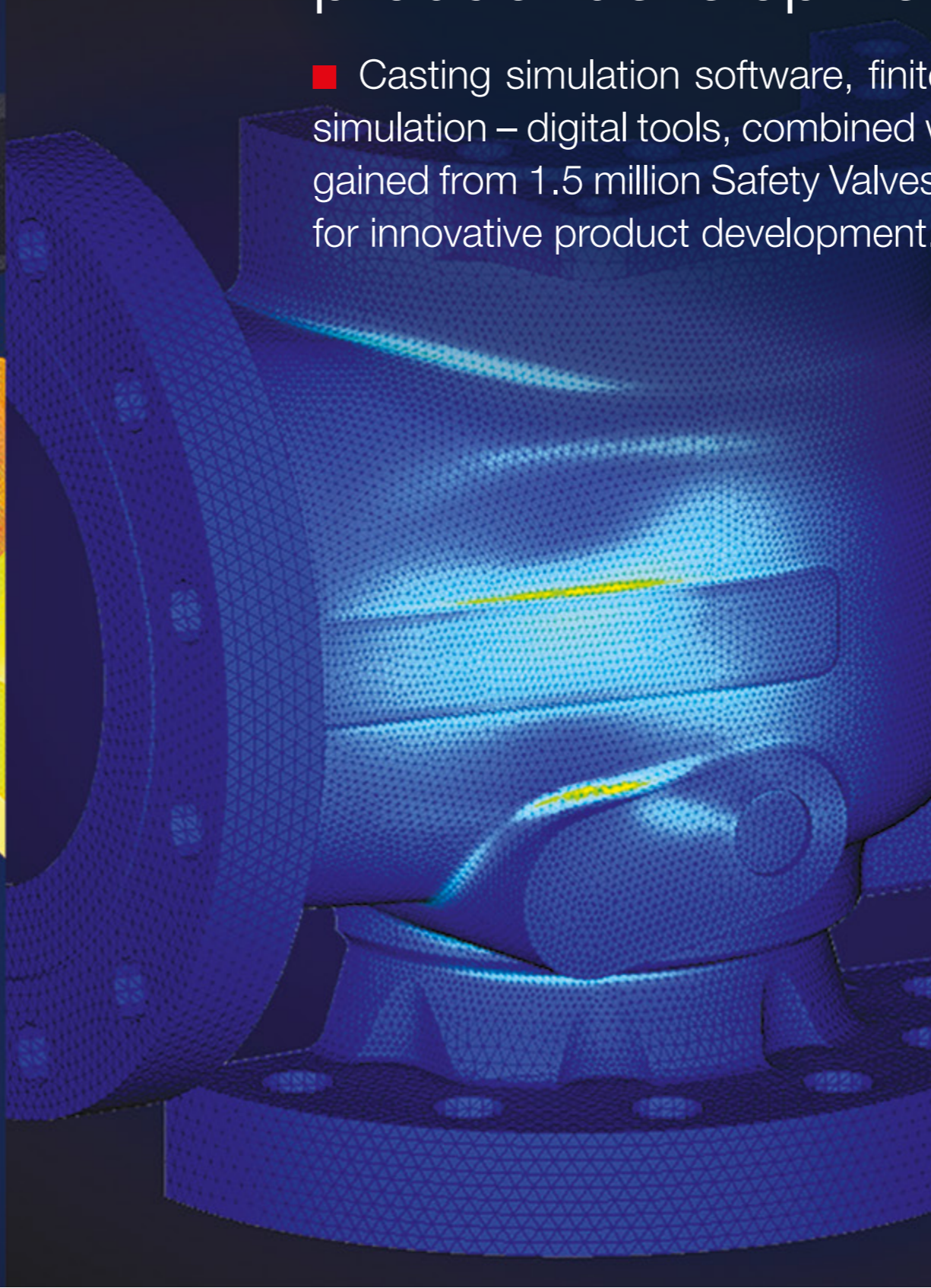
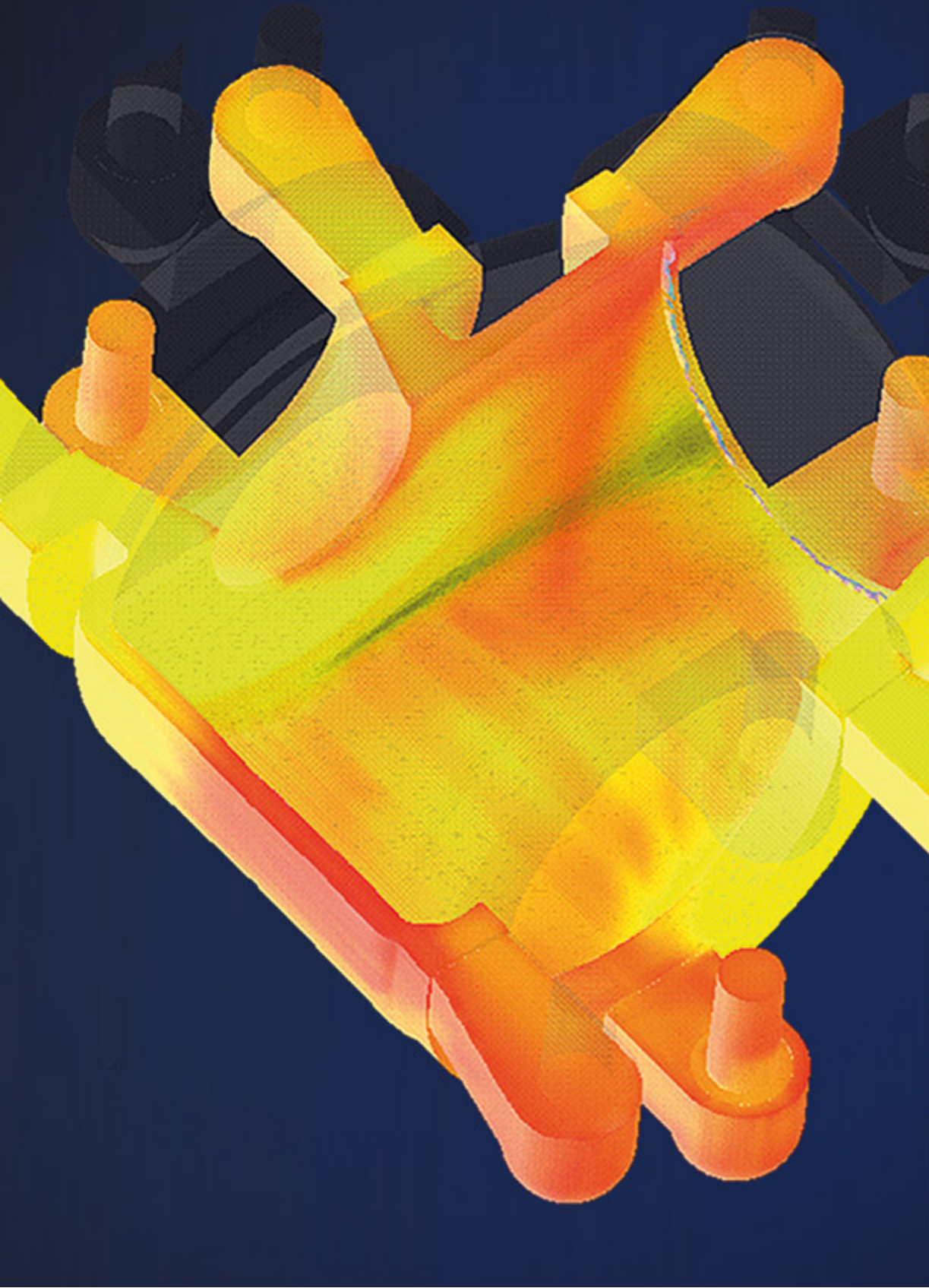

LESER is constantly learning.

■ Even the best simulation must be tested in practice. For steam, gases, and liquids, LESER operates its own certified test lab with a broad pressure and performance range.



The Safety Valve for the whole world.

■ LESER engineers ensure the worldwide use of our Safety Valves in your plant. Global standards, local regulations and requirements of classification associations are considered in the LESER product development. Moreover, LESER is an approved supplier to over 600 well-known customers from all industries.



Manufacturing with built-in quality.

■ 35 Quality inspections and tests are integrated in the LESER manufacturing process. These are comprehensively documented in SAP and guarantee traceability at all times. LESER is globally certified according to DIN EN ISO 9001 for all locations. This ensures consistent quality at all times.

SURFACE QUALITY TEST

Articlenumber: 4834

Material: 1.4435 / SA 479 316L

Value: Ra max 1.500 μm

Tolerance: = Rz 10 μm

Diagram:

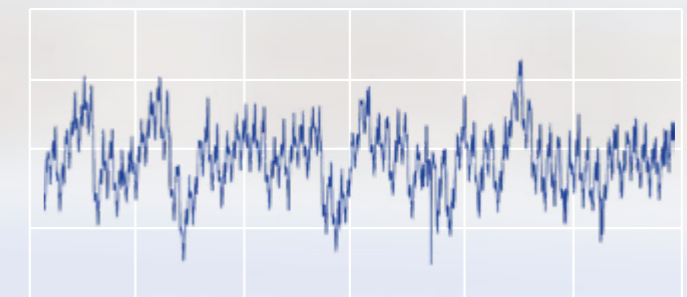

Fast, quantity and reliable.

■ The LESER delivery time promise is a consistently short delivery time for each product group, against which we are measured. This is achieved through parts availability, process structures, a wide range of variants and production that is designed to meet the requirements.



Flexible, precise and clear.

■ LESER separates projects and accepts no compromises in project execution. World market leaders from the oil & gas industry entrust LESER with the handling of their projects.



LESER – The Safety Valve for
all industrial applications.





Compact Performance

Safety Valves with compact dimension and variable connections

- Flanged and threaded valves with a flexible range of options to suit your application
- Bellows version available
- Set pressures up to 1.000 bar / 14,504 psig



High Performance

Safety Valves for all industrial applications

- The standard Safety Valve for chemical plants in Europe
- Easy maintenance
- High performance in relation to the nominal size
- Nominal inlet diameters from DN 20 / NPS ¾ to DN 400 / 16 with wide range of options
- Good price-performance ratio



API

Safety Valves according to API 526 with standardized capacities, installation dimensions and materials

- Standardized design and selection according to API 520
- Wide range of high-alloy materials available in standard delivery times
- Longer service life due to hardened discs, stellite seats and shielded bellows
- LESER Nanotightness exceeds API 527 tightness requirements by 50%

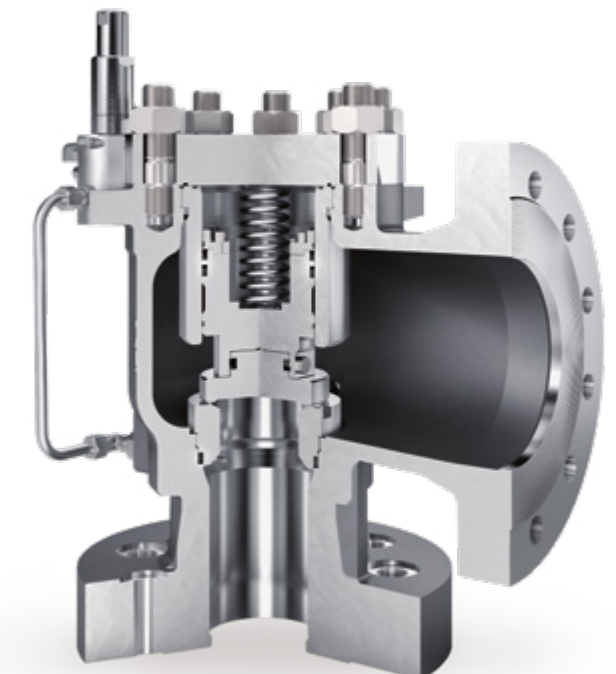

High Efficiency

Solutions for high plant efficiency

- Pilot-operated Safety Valves
- Spring-loaded Safety Valves with supplementary loading system
- Adaptation of the functional behavior to the operating conditions possible
- Tight up to set pressure
- Operating pressures up to 97% of set pressure
- Backpressures up to 95% of set pressure
- Low loss of medium during blow-off process

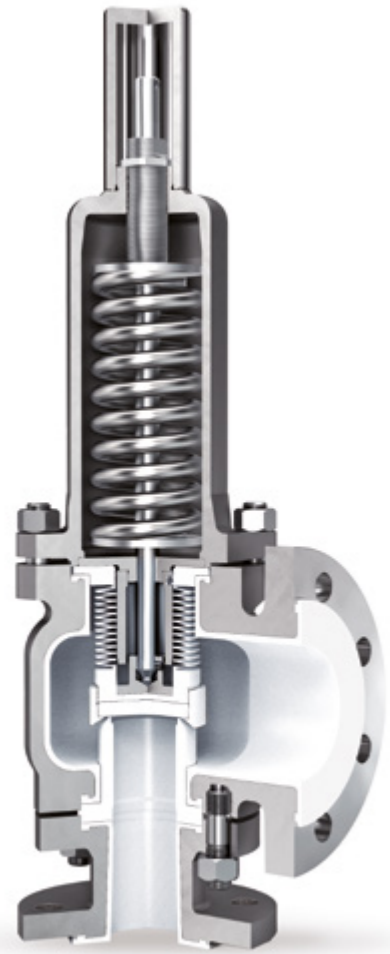

Critical Service

Safety Valves with PTFE lining for corrosive media

- Wetted areas made of corrosion-resistant PTFE
- Cost-effective alternative to high-alloy materials, such as nickel-based alloys
- Optional ATEX compliant lining prevents electrostatic charge



Clean Service

Safety Valves for food, beverage, and pharmaceutical applications

- Efficient cleaning due to low dead space ratio, gap-free design of internal parts, surface qualities up to Ra max = 0.375 µm
- Cleaning (CIP) or sterilization (SIP) possible in the process
- Compliant with market-relevant guidelines such as FDA, USP VI and EU directives
- Suitable selection of aseptic connections for your plant

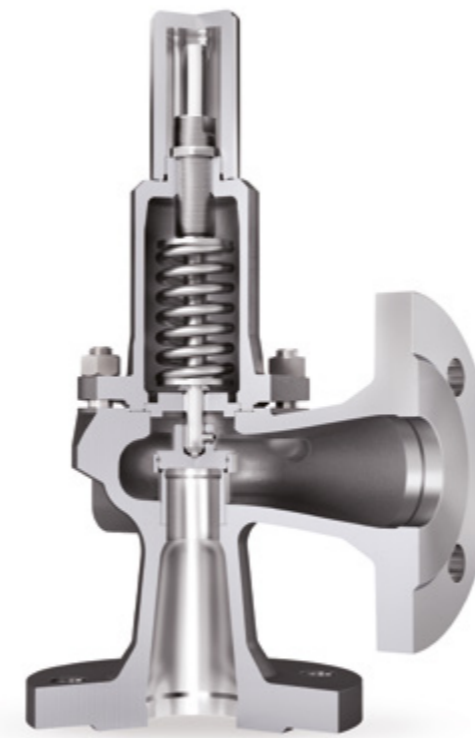

Modulate Action

Safety Valves primarily for liquid applications

- Identical inlet and outlet connections
- Low loss of medium when opening
- Ideal for thermal expansion
- Backpressure resistance up to 40 bar / 580.15 psig

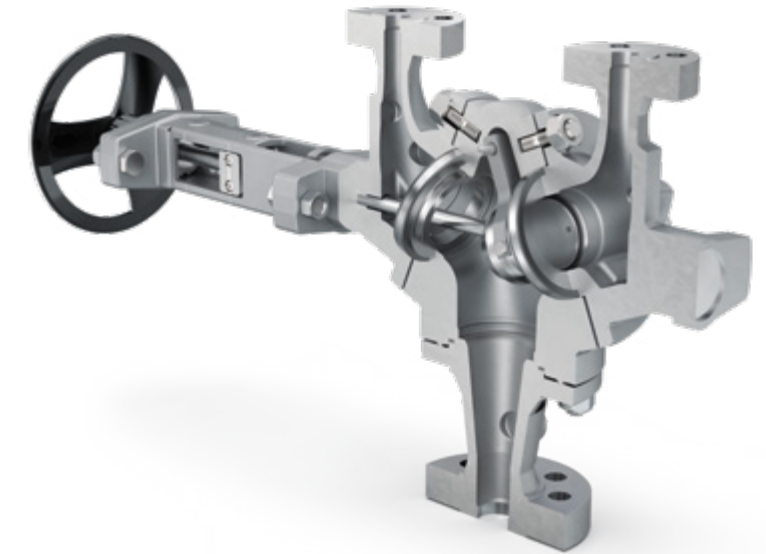

Best Availability

Solutions for high plant availability

- Change-over Valve / Safety Valve combination
- Safety Valve / rupture disc combination
- Flow-optimized designs for minimum inlet pressure drop
- Delivery times synchronized with the Safety Valves
- Certified combinations from a single source



eLESER. Digital makes it easier.

■ LESER offers you digital services around your Safety Valve. During the engineering stage of your plant, we support you with online training, VALVESTAR® and case studies for sizing and selection of your Safety Valves. With the ENGINEERING Handbook, a technical reference guide is available to you. Individual information on the status of your orders, on spare parts or certificates can be found online. eLESER has the right service for you!

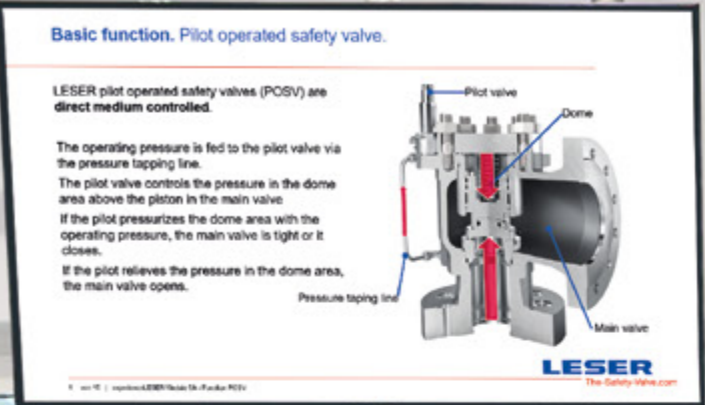

experienceLESER. Knowledge for more safety.

■ Expand your knowledge in coordinated modules. The technical training offers theory and practice directly with the safety valve in the LESER Chatroom and at the workbench. Trained professionals share their knowledge with you at the LESER Kontor, at your site or virtually around the world. However, a personal visit is always worthwhile to the LESER Kontor located in the metropolis of Hamburg. Here you will find the product exhibition, the LESER museum 1818 and the LESER Chatroom under one roof.



LESER – also with you afterwards.

■ With over 150 LESER Authorized Repair Centers (LARC), a worldwide network is available to you for the maintenance and repair of Safety Valves. Original spare parts and spare part kits are available at any time via the Digital ID directly on the valve or via eLESER. Maintenance information, instructions and videos for your Safety Valve can be found online.



Trust through transparency.

■ Whether know-how or price information, everything is always accessible. LESER's pricing is always transparent and clearly understood thanks to an annually published price book. Delivery time information is included here and the status of your delivery can be viewed online at any time.



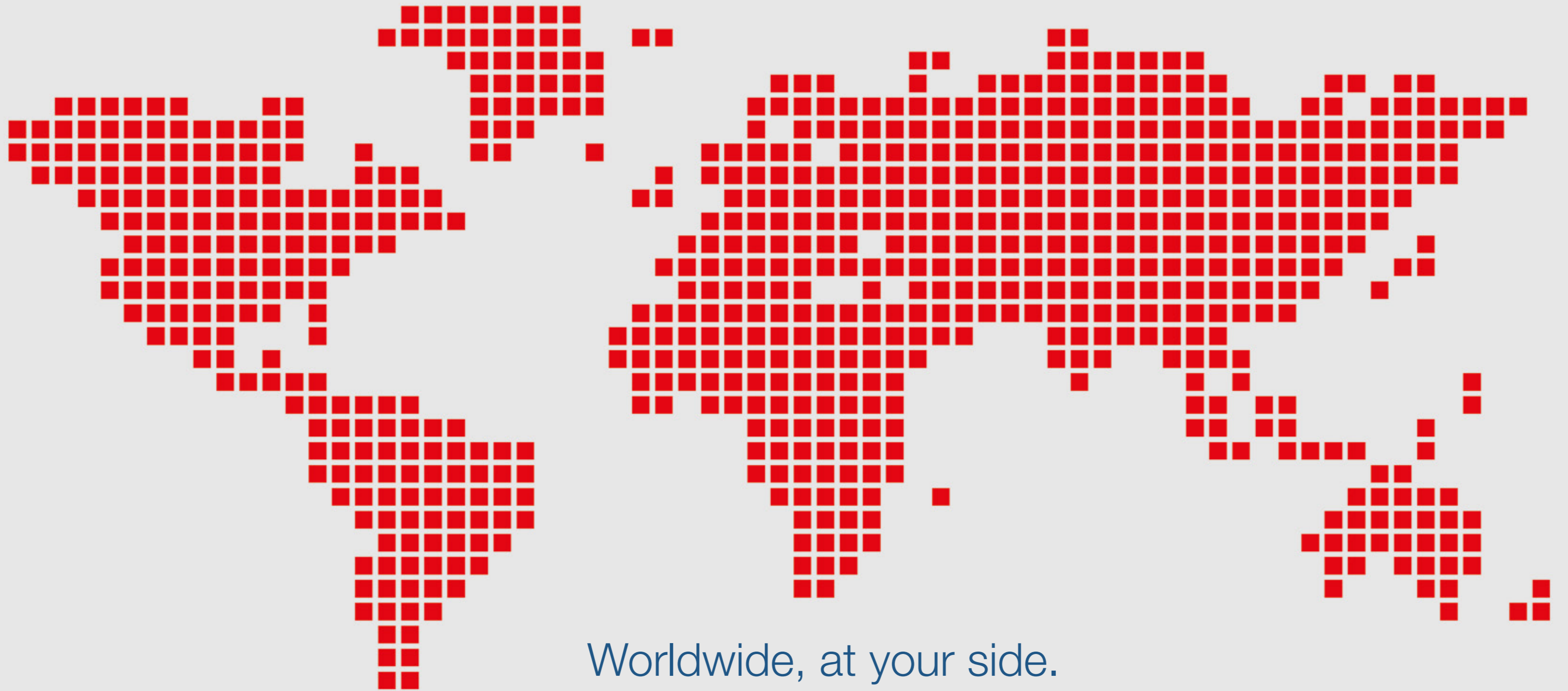

Worldwide, at your side.

■ In more than 100 countries, LESER subsidiaries, sales and service partners advise you on the selection, supply and maintenance of your Safety Valves.



LESER Kontor

The Home of Safety Valves

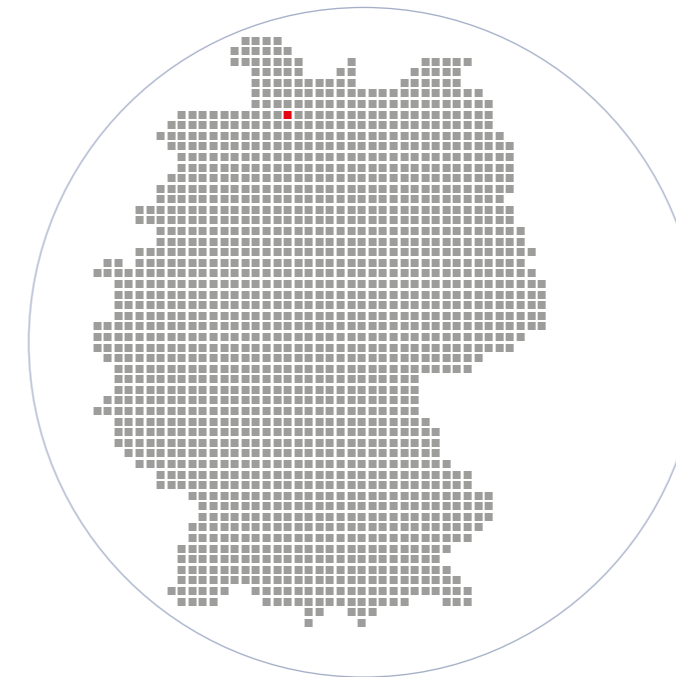

■ LESER's headquarters have been located at Wendenstrasse 133 in Hamburg, Germany, since 1914. The LESER Kontor was completely rebuilt at this location in 2016. Customers can experience LESER Safety Valves live: in the Chatroom, on the test lab, in the customer training rooms of experienceLESER, in the LESER 1818 museum and in the interactive product exhibition. That is why the LESER Kontor is "The Home of Safety Valves".



Employees at the 200th anniversary celebration



Product exhibition at LESER Kontor



LESER Hohenwestedt

The Factory of Safety Valves

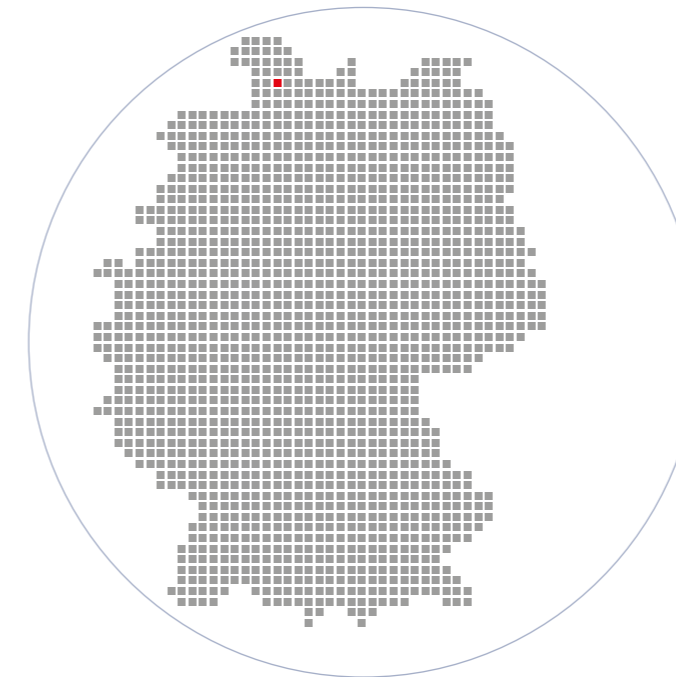

■ The LESER manufacturing plant in Hohenwestedt, Germany is the world's largest for safety valves of its kind. Qualified employees, automated production and intelligent warehousing form the basis for an on-time and economical production in Germany. Your Safety Valve is manufactured here.



Employees at the 200th anniversary celebration



Series assembly at LESER



LESER India

Global standards for the local market

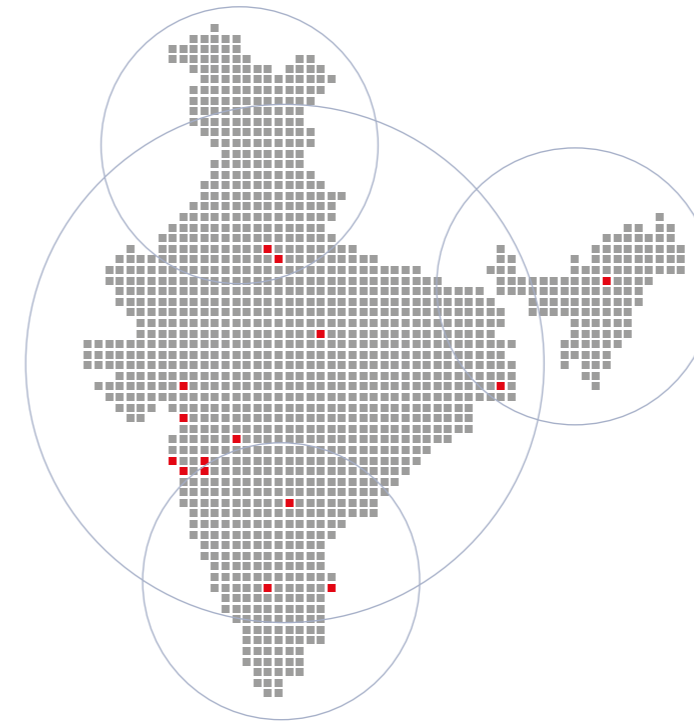

■ LESER India manufactures Safety Valves for the local Indian market at its ASME-approved production facility in Paithan, Aurangabad. The complete SAP integration guarantees short and reliable delivery times. Engineering, design, and product management on site enable application-related, tailor-made customer solutions. In-house test labs ensure subsequent validation. The local manufacturing and testing facilities are part of the LESER Global Quality Cluster.



Employees at the 200th anniversary celebration



Locally produced LESER Safety Valves



LESER China

Global quality manufactured in China

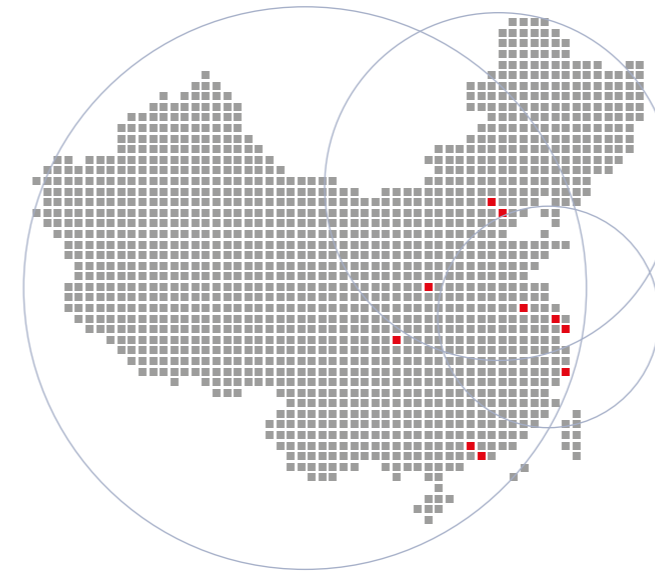

■ LESER China in Tianjin produces locally for the Chinese market with the same quality as in Germany. The localized Safety Valve program covers 90% of the industrial demand in China. With its own production, the subsidiary covers all aspects of a safety valve manufacturer. The LESER locations and the sales and service partner network ensure regional customer proximity throughout China.



Locally produced
LESER Safety Valves



LESER China, Tianjin
Manufacturing and
Administration Site



LESER North America

Fully committed to the USA and Canada

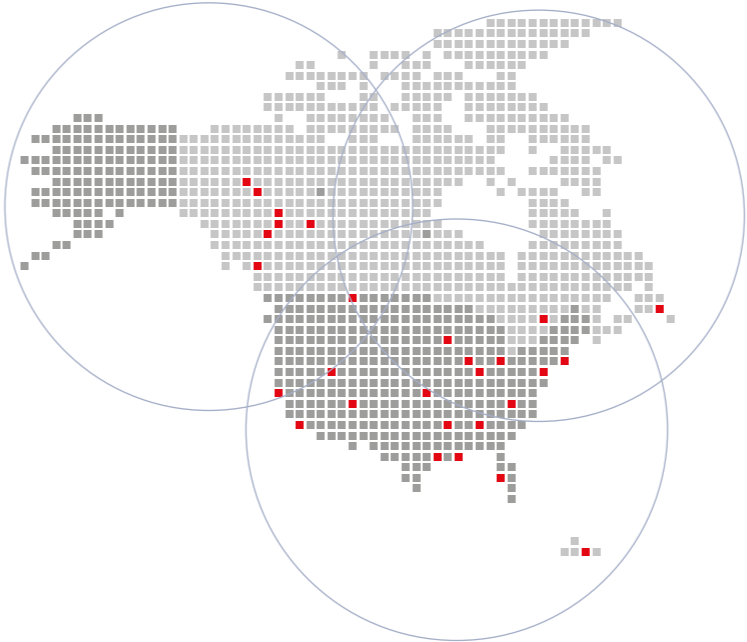

■ The North American headquarters in Charlotte, NC, USA oversees LESER’s extensive sales and service network in the region. LESER North America provides manufacturing competence for all local customers. Fully integrated SAP processes and the central warehouse enable same-day shipment of Safety Valves and spare parts when needed. On the Gulf Coast, the Houston sales office provides local support for this industrial region focusing on EPC customers and project business.



Employees in Charlotte



Employees in Houston sales office



LESER Brazil

Full service for the local market



■ LESER Brazil serves the Brazilian market through a network of sales and service partners. With the largest stock of safety valves in Latin America, LESER Brazil guarantees short and reliable delivery times. From technical consulting to coating and corrosion protection according to customer specifications and its own inspection center, everything is on-site for sophisticated project handling. With its VR-certified workshop, LESER Brazil performs maintenance and repair for the local oil & gas industry in the state of Rio de Janeiro. For other states in Brazil a LARC network is available.



LESER Brazil employees in front of the building in Rio de Janeiro



The broad spectrum of industries includes the oil and gas market with several FPSOs



LESER Latin America

Full service for the Spanish-speaking market



■ With 11,000 kilometers from north to south and 18 countries, the Spanish-speaking Latin America is one of the largest regions of the world. Since 2004, LESER built a sales and service partner network in this region. Today, LESER is represented in all industries with 20 sales and service partners supported by locally based Sales Market Developers. With this network, LESER provides local support with technical consulting and short delivery times to the market.



Latin America Sales Conference



One of many local warehouses in Latin America



LESER Southeast Asia

The hub for the region

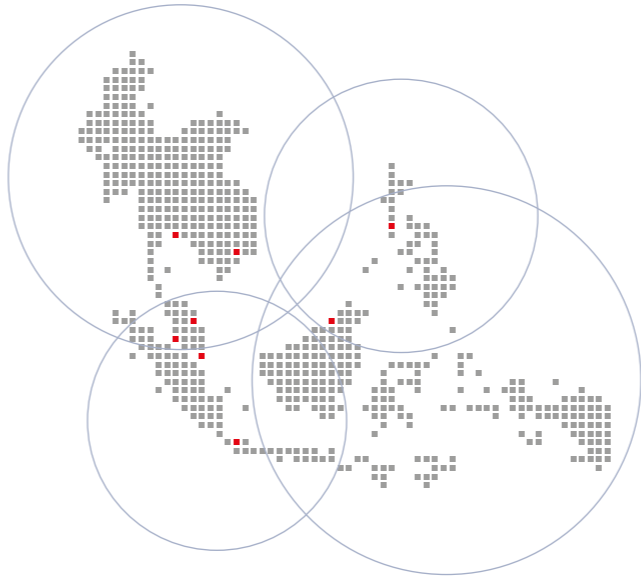

■ LESER in Singapore is the regional contact for all customers and partners in Southeast Asia. Experienced safety valve specialists look after the sales and service network. The subsidiary holds the local bizSAFE certification and is SINGLAS approved. LESER Authorized Repair Centers (LARC) in Malaysia, Indonesia and Thailand provide after-sales service and support. The warehouse ensures short reliable delivery times for the entire region.



Employees in the central warehouse in Singapore



Jurong Island in Singapore



LESER Middle East

Regional hub centered in Bahrain

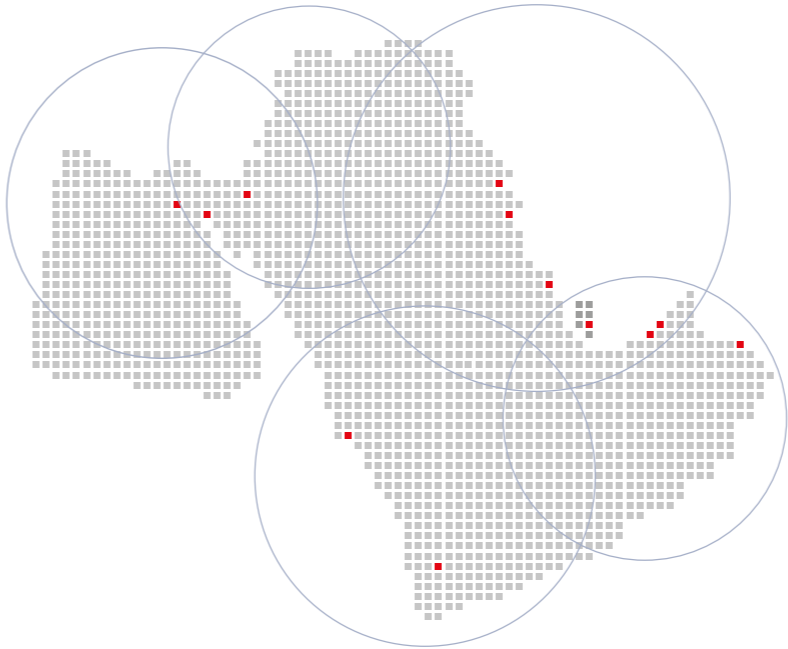

■ This subsidiary manages LESER’s sales and service network in the oil and gas centers of the Middle East. The team of experts for the oil & gas, petrochemical and nitrogen fertilizer industries ensures that LESER is a recognized supplier of safety valves to all customers in the region. LESER’s local content partner in Saudi Arabia, Binzagr, operates a safety valve assembly facility with an integrated warehouse, ensuring short and reliable delivery times.



Employees in the office of the regional center in Manama, Bahrain



Binzagr assembly for LESER Safety Valves in Saudi Arabia

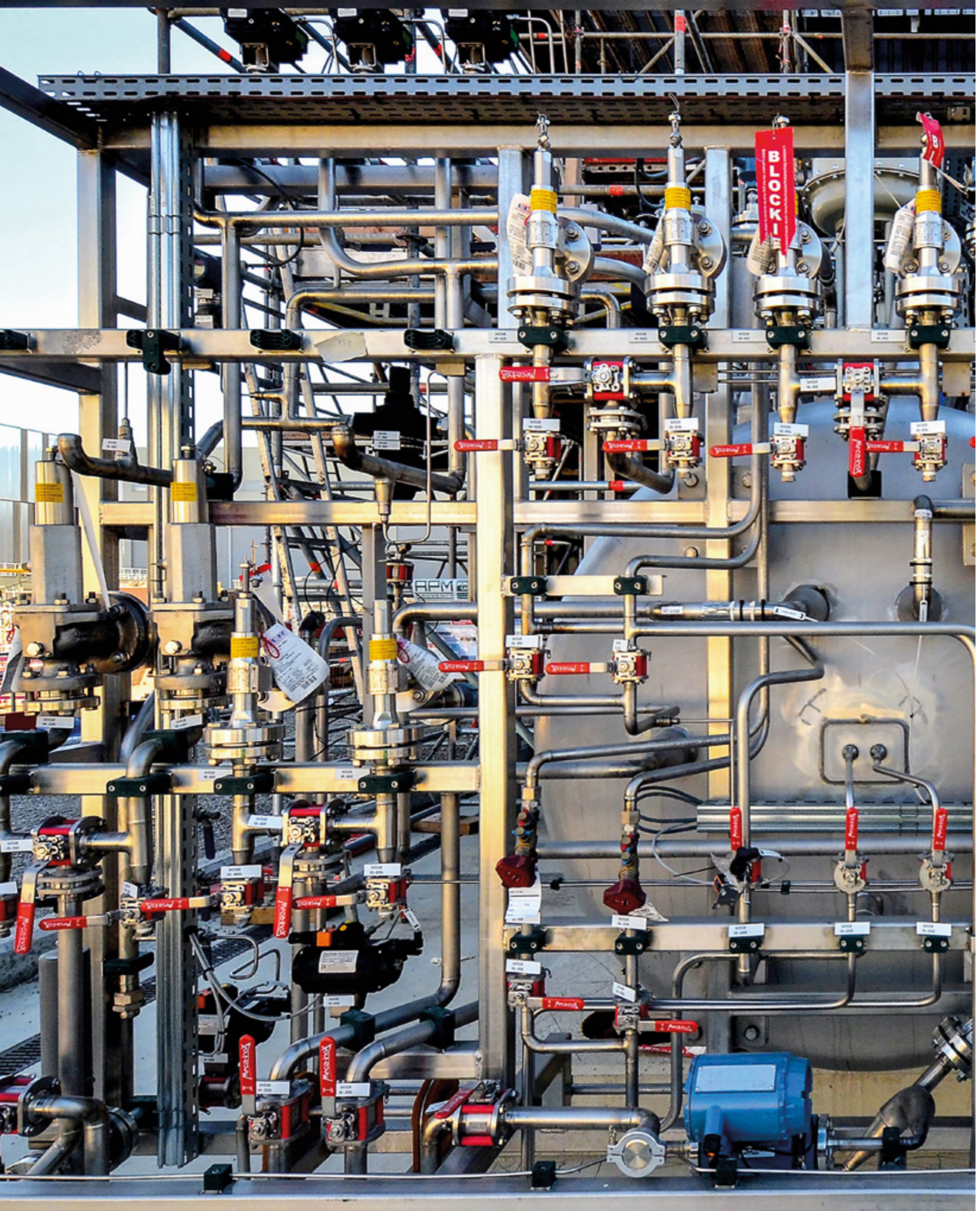

LESER France

Local presence for French-speaking markets

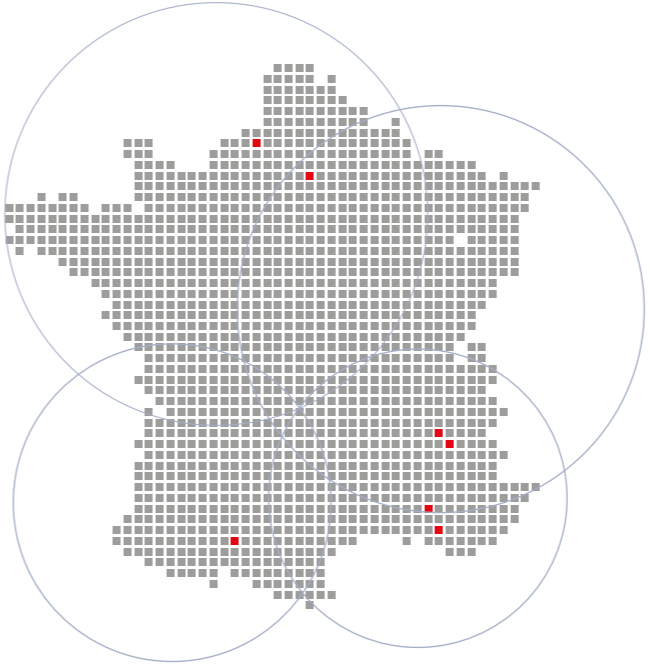

■ Since 2004, LESER France has developed into one of the market leaders. From here, customers from all industries in France and the French-speaking part of North Africa are served. An extensive sales network and export consultation provide customer-oriented solutions for all aspects of safety valves. Due to the proximity to the manufacturing plant in Germany, combined with a local warehouse, LESER France offers its customers short and reliable delivery times for the entire region.



Employees at the 200th anniversary celebration



Local valve adjustment at the central warehouse in Toulouse



LESER Poland

Sales and service for the local needs

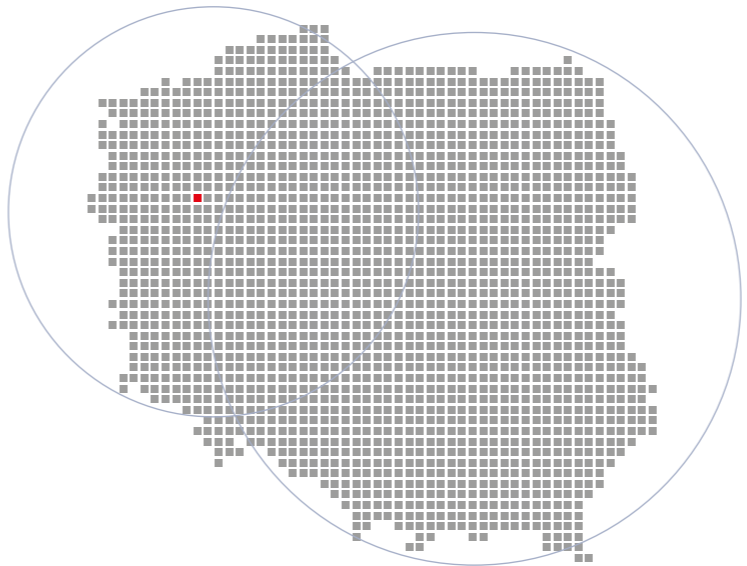

■ LESER has been present in the Polish market for its customers for many years. LESER Poland was founded to strengthen and expand the contacts with its customers. Today, the subsidiary offers its customers a full range of services for the selection, setting, maintenance and repair of Safety Valves.



LESER Poland



The headquarters of LESER Poland in Poznan

Stability for sustainable development. LESER is a fifth generation, family-owned company which provides financial stability and independence. LESER stands for: investments in employees and know-how, products, inventories, production, and quality. Continuous evolution in all areas of the company has made LESER a leading safety valve manufacturer. ■

LESER India

LESER India 136/137, Sanjay Bldg. No. 3, Mittal Estate, Marol
Andheri Kurla Road, Andheri 400 059 Mumbai | India
Fon +91 22-6893 3800 | sales@leser.co.in

www.leser.com

LESER
The-Safety-Valve.com